

# HITACHI

Color LCD TV

**USER'S MANUAL**

用户手册

用戶手册

**26LD8000TA - 2**

---

**READ THE INSTRUCTIONS INSIDE CAREFULLY.  
KEEP THIS USER'S MANUAL FOR FUTURE REFERENCE.**

For future reference, record the serial number of your television.

**SERIAL NO.** \_\_\_\_\_

The serial number is located on the rear of the television.

# USER'S MANUAL

Thank you very much for purchasing the HITACHI LCD Television. Before using your television, please carefully read the "SAFETY INSTRUCTIONS" and this "USER'S MANUAL" so you will know how to operate the television properly. Keep this manual in a safe place. You will find it useful in the future.

**Notes on Installation Work:**

This product is marketed assuming that it is installed by qualified personnel with enough skill and competence. Always have an installation specialist or your dealer install and set up the product. HITACHI cannot assume liabilities for damage caused by mistake in installation or mounting, misuse, modification or a natural disaster.

**Note for Dealers:**

After installation, be sure to deliver this manual to the customer and explain to the customer how to handle the product.

### **Important**

Please read this User's Manual thoroughly, especially the Safety Instructions on Page 4 to 8. Mis-use may cause damage to your LCD television, which could shorten its lifespan, or cause injury to yourself. Should you encounter any difficulty in the set-up or operation of your television, firstly refer to the Troubleshooting guide at the rear of this manual.

In the unlikely event of a problem occurring with your LCD television, switch off at the mains sockets, pull out the plugs, and contact your dealer immediately.

### **CAUTION**

Under no circumstances remove the rear cover of your LCD television.

Never guess or take any chances with electrical equipment of any kind - it is better to be safe than sorry!

### **Software Notice**

It is prohibited for the end user of this product to copy, reverse engineer or reverse compile the software included therein, save to the extent permitted by law.

### **LCD Television**

After the LCD television has been on for any length of time, you will notice that the screen becomes warm. Please note that this is normal.

Sometimes the screen might have some tiny bright or dark spots. Please note that this is normal.

### **CAUTION**

To prevent scratches or damages to the LCD screen, do not knock or rub the surface with sharp or hard objects. Clean the screen with a soft cloth moistened with warm water and dry with a soft cloth. A mild soap may be used if the screen is extremely dirty. Do not use harsh or abrasive cleaners!

### **CAUTION**

Use a soft cloth to clean the cabinet and control panel of the television. When excessively soiled dilute a neutral detergent in water, wet and wring out the soft cloth and afterward wipe with a dry soft cloth.

Never use acid/alkaline detergent, alcoholic detergent, abrasive cleaner, powder soap, OA cleaner, car wax, glass cleaner, etc. especially because they would cause discoloration, scratches or cracks.

## **FEATURES**

### **Large-screen, high-definition LCD panel**

The 26-inch color LCD panel, with a resolution of 1366 (H) x 768(V) pixels, creates a high-definition, large-screen (aspect ratio : 16:9) and low-profile flat display. Free from electromagnetic interferences from geomagnetic sources and ambient power lines, the panel produces high-quality display images free from color misconvergence and display distortion.

### **High Performance Digital Processor**

A wide range of input signals can be handed, including composite, component.

In addition, it corresponds to a broad array of personal computer signals, from 640 x 480 VGA to 1280 x 768 WXGA. (Analog Input)

### **Easy-to-use remote control and on screen display system**

The remote control included eases the work of setting display controls. Further, the on-screen display system, displays the status of signal reception and display control settings in an easy-to-view fashion.

### **Power saving system**

When connected to a VESA DPMS-compliant PC, the television cuts its power consumption while it is idle.

### **Connecting to an Audio Visual Device**

- Two composite/S terminals\*1, two component terminals. A composite video output terminal is also provided as a television output.

\* 1 A composite/S terminal = A side input

- A wide range of devices can also be connected besides personal computers.

## CONTENTS

FEATURES.....	2
SAFETY INSTRUCTIONS.....	4
NOTES.....	8
ACCESSORIES.....	9
HOW TO SET UP YOUR NEW HITACHI LCD TELEVISION.....	10
FRONT PANEL CONTROLS.....	12
TOP SIDE PANEL CONTROLS.....	13
REAR PANEL MAIN POWER SWITCH & JACKS.....	14
SIDE PANEL CONTROLS.....	16
CONNECTING EXTERNAL SOURCES.....	17
Remote Controller Buttons and Functions.....	20
Teletext Function.....	25
OSD(On-Screen Display).....	26
Self Diagnosis Function.....	35
PRODUCT SPECIFICATIONS.....	37

### Notes about This Manual

- The information in this manual is subject to change without notice.
- While meticulous care has been taken in the preparation of this manual, you are requested to notify your dealer or us should you have any comments, views or questions about our product.
- Fully understand the prerequisites to using the product, such as hardware and software specifications and constraints, in using the product. We are not held liable for damages caused by improper handling of the product.
- Reproduction of this manual in whole or in part without our prior written permission is prohibited.
- The product names mentioned in this manual may be trademarks or registered trademarks of their respective owners.

## SAFETY INSTRUCTIONS

This LCD television has been designed and manufactured to meet international safety standards, but like any electrical equipment, care must be taken if you are to obtain the best results and safety is to be assured. Before using this product, please read and understand the Safety Instructions thoroughly to ensure correct usage, and follow all the instructions.

### About the Symbols

Various symbols are used in this manual, the user's manual and on the product itself to ensure correct usage, to prevent danger to the user and others, and to prevent property damage. The meanings of these symbols are described below. It is important that you read these descriptions thoroughly and fully understand the contents.



**WARNING**

This symbol indicates information that, if ignored, could possibly result in personal injury or even death due to incorrect handling.



**CAUTION**

This symbol indicates information that, if ignored, could result possibly in personal injury or physical damage due to incorrect handling

#### Typical Symbols



This symbol indicates an additional warning (including cautions). An illustration is provided to clarify the contents.



This symbol indicates a prohibited action. The contents will be clearly indicated in an illustration or nearby (the symbol to the left indicates that disassembly is prohibited).



This symbol indicates a compulsory action. The contents will be clearly indicated in an illustration or nearby (the symbol to the left indicates that the power plug should be disconnected from the power outlet)



**WARNING**

#### Never use the television if a problem should occur.

Abnormal operations such as smoke, strange odor, no image, no sound, excessive sound, damaged casing, elements, cables, penetration of liquids or foreign matter, etc. can cause a fire or electrical shock.

In such case, immediately turn off the power switch and then disconnect the power plug from the power outlet. After making sure that the smoke or odor has stopped, contact your dealer. Never attempt to make repairs yourself because this could be dangerous.



Disconnect the plug from the power outlet.

#### Do not insert liquids or foreign objects.

Penetration of liquids or foreign objects could result in fire or electrical shock. Use special caution in households where children are present.

If liquids or foreign objects should enter the television, immediately turn off the power switch, disconnect the power plug from the power outlet and contact your dealer.

- Do not place the television in a bathroom.
- Do not expose the television to rain or moisture.
- Do not place flower vases, pots, cups, cosmetics, liquids such as water, etc on or around the television.
- Do not place metals, combustibles, etc on or around the television.



#### Never disassemble or modify the television.

The television contains high voltage components. Modification could result in fire or electrical shock.

- Never remove any fixed cover.



Do not disassemble.

#### Do not give the television any shock or impact.

If the television should be shocked and/or broken, it could result in an injury, and continued use could result in fire or electrical shock. If the glass panel is broken or damaged, immediately turn off the power switch, disconnect the power plug from the power outlet and contact your dealer.



#### Do not place the television on an unstable surface.

If the television should be dropped and/or broken, it could result in an injury, and continued use could result in fire or electrical shock.

- Do not place the television on an unstable, slant or vibrant surface such as a wobbly or inclined stand.



#### Do not obstruct the ventilation of the television.

If the ventilation is obstructed during the operation of the television or just after switching off the power, it could result in damage and shorten the lifespan of your television due to overheating. Make sure there is ample ventilation.

- Keep a space of 100mm (10cm) or more between the sides, rear and top of the television and other objects such as walls.
- Do not place anything around ventilation openings of the television.
- Never block ventilation openings.
- Do not put the LCD panel side up.
- Do not cover the television with a tablecloth, etc.
- Do not place the television on a carpet or bedding, or near a curtain.



#### Use only the correct power outlet.

Incorrect power supply could result in fire or electrical shock. Use only the correct power outlet depending on the indication on the television and the safety standard.

- The enclosed power cord must be used depending on the power outlet to be used.



## SAFETY INSTRUCTIONS (continued)

### About the Symbols (continued)

#### WARNING

##### **Be cautious of the power cord connection.**

Incorrect connection of the power cord could result in fire or electrical shock.

- Do not touch the power cord with a wet hand.
- Check that the connecting portion of the power cord is clean (with no dust), before using. Use a soft and dry cloth to clean the power plug.
- Insert the power plug into a power outlet firmly. Avoid using a loose, unsound outlet or contact failure.
- Do not cut off the fitted power plug, the removal of which could lead to impaired performance. If you wish to extend the lead, obtain an appropriate extension lead or consult your dealer.
- Should you require replacing the fuse in the molded plug with a new fuse, then please replace with new one of the same value, type and approval as the original. Ensure the fuse cover is returned to its original position.



##### **Be sure to keep safety ground connection.**

Connect the ground terminal of AC inlet of this television with the ground terminal provided at the power outlet using the enclosed power cord. If the provided plug does not fit your outlet, consult an electrician for replacement of the obsolete outlet.



Surely connect the ground wire.

##### **Be careful in handling the power cord and external connection cables.**

If you keep using a damaged the power cord or cables, it can cause a fire or electrical shock. Do not apply too much heat, pressure or tension to the power cord and cables.

If the power cord or cables are damaged (exposed or broken cord wires, etc.), contact your dealer.

- Do not place the television or heavy objects on the power cord and cables. Also, do not place a spread, cover, etc, over them because this could result in the inadvertent placing of heavy objects on the concealed power cord or cables.
- Do not pull the power cord and cables. When connecting and disconnecting the power cord or cables, do it with your hand holding the plug or connector.
- Do not place the cord near the heater.
- Do not touch the power plug just after disconnecting it from the power outlet to prevent electric shock.
- Do not touch the power plug when lightening is close to you.
- Avoid coiling the power cord and bending it sharply.
- Protect the power cord from being walked on, pinched particularly at plugs, conveniences receptacles, and the point where they exit from the apparatus.
- Do not modify the power cord.



##### **Be careful in handling the battery of the remote control.**

Incorrect handling of the battery could result in fire or personal injury. The battery may explode if not handled properly.

- Keep the battery away from children and pets. If swallowed consult a physician immediately for emergency treatment.
- Do not allow the battery to be exposed to fire or water.
- Avoid fire or high-temperature environment.
- Do not hold the battery with metallic tweezers.
- Keep the battery in a dark, cool and dry place.
- Do not short circuit the battery.
- Do not recharge, disassemble or solder the battery.
- Do not physically impact the battery.
- Use only the battery specified in the manual of this television.
- Make sure the plus and minus terminals are correctly aligned when loading the battery.
- If you observe a leakage of the battery, wipe out the liquid and then replace the battery. If the liquid adheres your body or clothes, rinse well with water.
- Obey the local laws on disposing the battery.
- Attention should be drawn to the environmental aspects of battery disposal.
- No naked flame source such as lighted candles should be placed on the apparatus.
- The use of apparatus in moderate climates.



## SAFETY INSTRUCTIONS (continued)

### About the Symbols (continued)

#### CAUTION

##### **Be careful in moving the television**

Neglect could result in an injury or damage.

- Do not move the television during use. Before moving, disconnect the power plug and all external connections.
- You are advised to move the television with two persons.
- Avoid any impact or shock to the television; particularly take care of glass screen.



##### **Do not put anything on top of the television.**

Placing anything on the television could result in loss of balance or falling, and cause an injury or damage. Use special caution in households where children are present.



##### **Avoid a humid or dusty place.**

Placing the television in a smoke, a highly humid, dusty place, oily soot or corrosive gas could result in fire or electrical shock.

- Do not place near the kitchen, a humidifier or other place where there is oil, smoke or humidity.



##### **Avoid a high temperature environment.**

The heat could have adverse influence on the television and other parts, and could result in transformation, melting or fire.

- Do not place the television, the remote control and other parts in direct sunlight or near a hot object such as heater, etc.
- Do not put the television in a place where the temperature is widely changing.



##### **Remove the power cord for complete separation.**

- For safety purposes, disconnect the power cord if the television is not to be used for prolonged periods of time.
- Before cleaning, turn off and unplug the television. Neglect could result in fire or electrical shock.



Disconnect the plug from the power outlet.

#### PRECAUTIONS

##### **Installation environment**

Do not obstruct a ventilation hole.

Do not put the television on carpet or blanket, or near a curtain which has a possibility of obstructing a ventilation hole of the television. Do not put the television in the following places.

- Hot places such as near heater, place exposed to the direct rays of the sun.
- A place where the temperature is widely changing.
- Places with soot, dust or high humidity.
- Poor air ventilation place.
- Place near fire.
- A wet place such as bathroom, or shower room.
- Place where you can trip over it.
- Always vibrating or strongly vibrating places.
- Distorted or unstable places.

##### **How to view the television**

If you use the television in too dark a room, your eyes may become tired. Please use it in a reasonably bright room.

Avoid direct rays of the sun to the screen in order to prevent eye fatigue. Your eyes will get fatigued after viewing the television for long period of time. Relax your eyes by viewing away from the television from time to time.

Please watch the television in downward direction.

##### **How to clean the LCD panel of the television**

Before cleaning the television, turn off the television and disconnect the power plug from the power outlet.

To prevent scratching or damaging the LCD screen face, do not knock or rub the surface with sharp or hard objects. Clean the screen with a soft cloth moistened with warm water and dry with a soft cloth. If it is not enough, then use a cloth with mild detergent. Do not use harsh or abrasive cleaners.

##### **How to clean the cabinet of the television**

Use a soft cloth to clean the cabinet and control panel of the television. When excessively soiled dilute a neutral detergent in water, wet and wring out the soft cloth and afterward wipe with a dry soft cloth.

Never use acid/alkaline detergent, alcoholic detergent, abrasive cleaner, powder soap, OA cleaner, car wax, glass cleaner, etc. especially because they would cause discoloration, scratches or cracks.

## SAFETY INSTRUCTIONS (continued)

### About the Symbols (continued)

ENGLISH

#### Prevention of an obstacle to Radio receivers

This television has been designed pursuant to the international EMI standards. This is to prevent a problem to Radio receivers.

- Keep the television away from Radio.
- Adjust Radio antennas in order for the television not to receive interference.
- The antenna cable of Radio should be kept away from the television.
- Use a coaxial cable for antenna.

You can check if this television influences Radio receivers by turning off all other equipment other than the television. If you find a problem receiving Radio when using the television, check the instructions mentioned above.

#### Precautions for the cable connection

- Do ensure that all connections, (including the power plug, extension leads and interconnections between the pieces of equipment), are properly made and in accordance with the manufacturers instructions. Switch off and withdraw the power plug before making or changing connections.
- Confirm the connector is fixed tightly when the signal cable is connected. Also confirm the screws on the connector are tightened.
- Plug the power cord of the television into a different socket from that for other equipment, such as Radio etc.
- Use a plug with ground terminal and make sure that it connects to the ground.

#### Precaution during transportation

Please pay attention when you transport this television because it is heavy.

Furthermore, use the original carton box and its packaging materials when the television is transported. Failure to transport the television in any carton except the original carton may result in damage to the television. Save the original carton box and all packing material.

#### Do not physically impact the remote control.

A physical impact could cause damage or malfunction of the remote control.

- Take care not to drop the remote control.
- Do not place heavy objects on the remote control.

#### Avoid strong rays.

Any strong rays (such as direct sun rays or room lighting) onto the remote control sensors could invalidate the remote control.

#### Avoid radio interference.

Any interfering radiation could cause distorted images or noises.

- Avoid radio generator such as a mobile telephone, transceiver, etc. around the television.

#### Set the sound volume at a suitable level.

It is better to keep the volume level low and close the windows at night to protect the neighborhood environment.

#### Precautions for the installation

- Do not use makeshift stands and NEVER fix legs with wood screws - to ensure complete safety, always fit the manufacturers approved stand or legs with the fixings provided according to the instructions.
- Use only with the cart, stand, tripod, bracket, or table specified by the manufacturer, or sold with the apparatus. When a cart is used, use caution when moving the cart/apparatus combination to avoid injury from tip-over.
- This product is designed to comply with the recommended safety standards for tilt and stability. Do not apply excessive pulling force to the front, or top, of the cabinet that could cause the product to overturn resulting in product damage and/or personal injury.
- Follow instructions for wall, shelf or ceiling mounting as recommended by the manufacturer.
- Only use the attachments/accessories specified by the manufacturer.
- Consult your dealer if you are in any doubt about installation, operation or safety of your equipment.

#### Other precautions

- Do not leave equipment switched on when it is unattended unless it is specifically stated that it is designed for unattended operation or has a stand-by mode. Switch off using the switch on the equipment and show your family how to do this. Make special arrangements for infirm or handicapped people.
- Disposal of this product may require specific instructions pertaining to your resident region.
- Never guess or take any chances with electrical equipment of any kind - it is better to be safe than sorry!



## Notes

### **About screen defects**

- High precision technology is used in the making of LCD panels but there may be dark spots (points that do not illuminate) and bright spots (points that are too bright) in some cases. These do not indicate a malfunction.

### **About residual images**

- In some cases, residual images may remain after the short-term display of still images and another image is displayed, but these will disappear and return to normalcy. This is not a malfunction.

### **About the panel screen**

- LCD screens display images by means of electrical discharges inside the panel. Because of this, the temperature of the panel surface may rise in some cases. Also, LCD panels are made of finely processed glass. A reinforced glass filter is installed over the panel surface but avoid strong impact because there is still danger of glass breakage.

### **Using in low temperatures**

- The response speed of LCD panel becomes slow as the ambient temperature goes down. This feature may cause residual images in some cases, but this is not a malfunction. It will return to normal in a while after the temperature becomes normal.

## ACCESSORIES

Check to make sure you have the following accessories before disposing of the packing material.

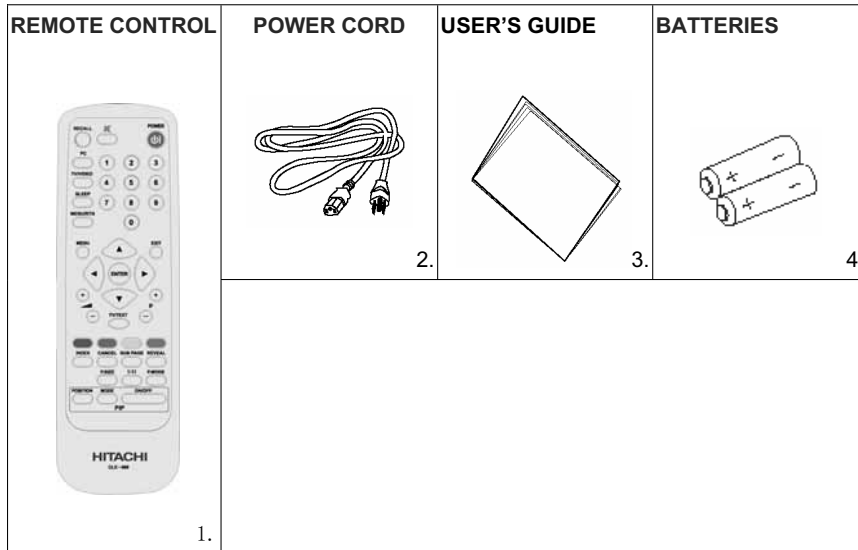

ENGLISH



**CAUTION:** Ceiling mounting is not recommended. Mounting the panel on the ceiling does not provide adequate ventilation for the electronics or proper support for the front glass panel. This LCD television product is designed for a maximum tilting angle of 20 degrees from vertical.

1. Remote Control Unit
2. Power Cord
3. User's Guide
4. Two "AAA" size, 1.5V batteries

## REMOTE CONTROL BATTERY INSTALLATION AND REPLACEMENT

1. Open the battery cover of the remote control by pressing the notched part of the cover with your fingers and pulling the cover off.
2. Insert two new "AAA" size batteries for the remote control. When replacing old batteries, push them towards the springs and lift them out.
3. Match the batteries to the (+) and (-) marks in the battery compartment.
4. Replace the cover.



### CAUTION

- Do not use new and old batteries together. The batteries could explode or leak, resulting in fires, physical injury, or stains.
- When loading batteries, observe their correct polarities as marked on the product. If loaded in the wrong direction, the batteries could explode or leak, resulting in fires, physical injury, or stains.

### BOTTOM VIEW

(Remote Control)

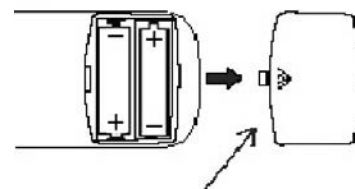

Press and pull the back cover to remove.

## HOW TO SETUP YOUR NEW HITACHI LCD TELEVISION

To take measures to prevent the LCD Television from tipping over and prevent possible injury it is important to mount the unit in a stable place.

### Securing to a wall

\*Keep the LCD Television four inches away from the wall except those hung to the wall mount bracket.

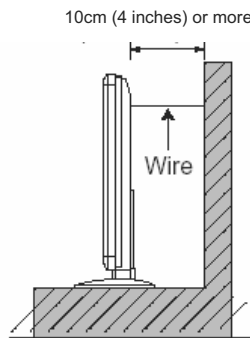

- NOTES:**
1. Do not block the ventilation holes of the LCD Television. Blocking the ventilation holes might cause fire or defect.
  2. If you purchased the wall mount bracket option, please ask for professional installer. Do not install by yourself.
  3. Please use the general purpose rope to fix the TV set on the solid wall firmly.

### Power Cord Connection

Connect the power cord, after completing all other connections.

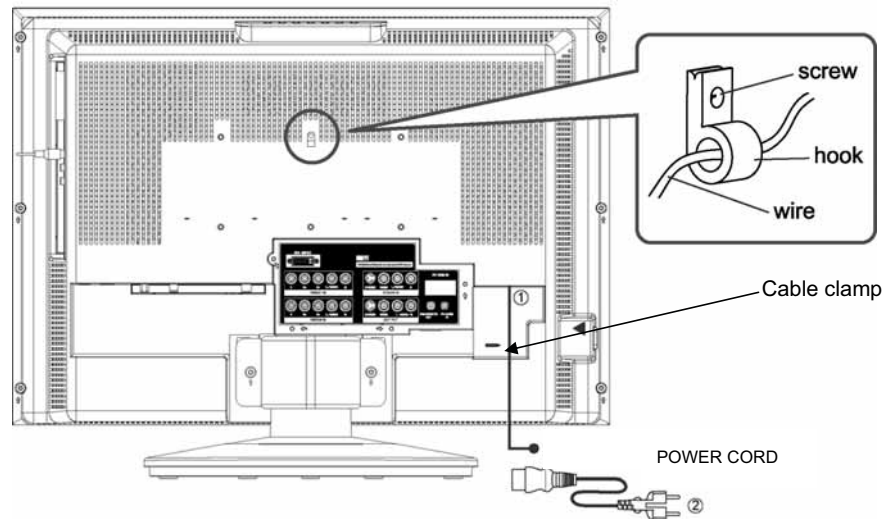

① Connect the power cord to this device.

② Connect the power cord plug to the power outlet.

(The type of the plug is different from this drawing for some countries.)

Note: There is a wire hook on top of TV back cover, please use durable wire tied on the hook to prevent the TV set from toppling.

## HOW TO SETUP YOUR NEW HITACHI LCD TELEVISION

### Caution when moving the main unit

As this product is heavy, whenever it is moved, two people are required to transport it safely. Whenever the unit is moved it should be lifted forward using the top and base on both sides for stability. When moving the LCD Television, lift the top and the bottom frame as shown below.

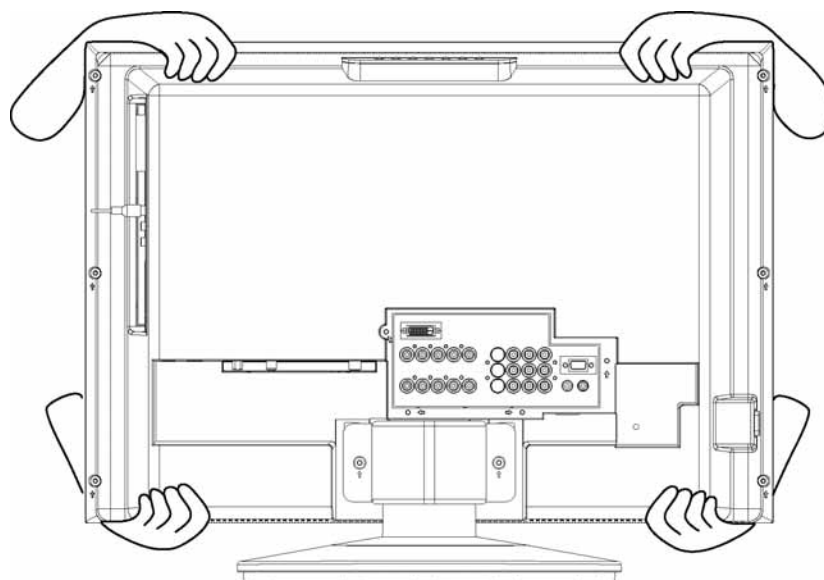

### ANTENNA

Unless your LCD television is connected to a cable television system or to a centralized antenna system, a good outdoor color television antenna is recommended for best performance. However, if you are located in an exceptionally good signal area that is free from interference and multiple image ghosts, an indoor antenna may be sufficient.

### LOCATION

Select an area where sunlight or bright indoor illumination will not fall directly on the picture screen. Also, be sure that the location selected allows a free flow of air to and from the perforated back cover of the set.

To avoid cabinet warping, cabinet color changes, and increased chance of set failure, do not place the television where temperatures can become excessively hot, for example, in direct sunlight or near a heating appliance, etc.

## FRONT PANEL CONTROLS

### Front VIEW

26" LCD Television

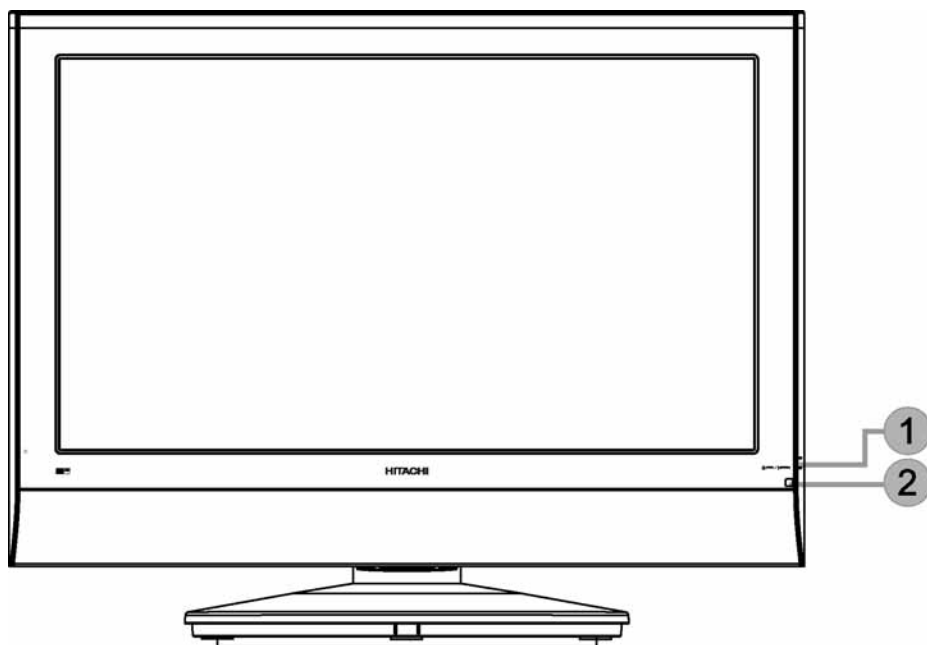

#### ① POWER light indicator

To turn the television ON, press the main power button located on the BACK right side of the television. A red stand-by indicator lamp located on the lower right corner of the front bezel will illuminate. The LCD television is now ready for remote on/off operation.

Indicating Lamp	Power Status	Operating
Off	Off	When the MAIN POWER is set OFF.
Lights Red	Off (Stand-by)	When the MAIN POWER is set ON and the Front Key or Remote Control POWER is Off.
Lights Orange	Off (Power Saving)	1. When the MAIN POWER is set ON. 2. No signal input.
Lights Green	On	When the POWER is ON.

#### ② REMOTE CONTROL sensor

Point your remote at this area when selecting channels, adjusting volume, etc.

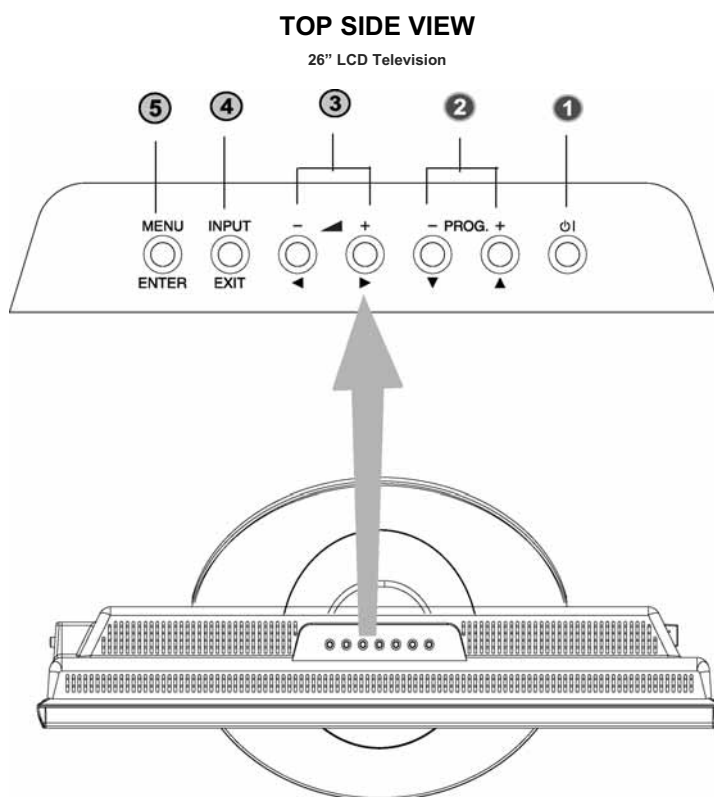

① **SUB-POWER button**

This power button is for power on the LCD television or change to standby mode.

② **CHANNEL selector**

Press these buttons until the desired channel appears in the top left corner of the television screen. These buttons also serve as the cursor down (▼) and up (▲) buttons when in MENU mode.

③ **VOLUME level**

Press these buttons to adjust the sound level. The volume level will be displayed on the television screen. These buttons also serve as the cursor left (◀) and right (▶) buttons when in MENU mode.

④ **INPUT/EXIT button**

Press this button to select the desired input: ANTENNA, VIDEO1, VIDEO2, VIDEO3, VIDEO4, PC RGB. This button also serves as the EXIT button when in MENU mode.

⑤ **MENU/ENTER button**

This button allows you to enter the MENU, making it possible to set television features to your preference without using the remote. This button also serves as the ENTER button when in MENU mode.

## REAR PANEL MAIN POWER SWITCH & JACKS

Rear view  
26" LCD TV

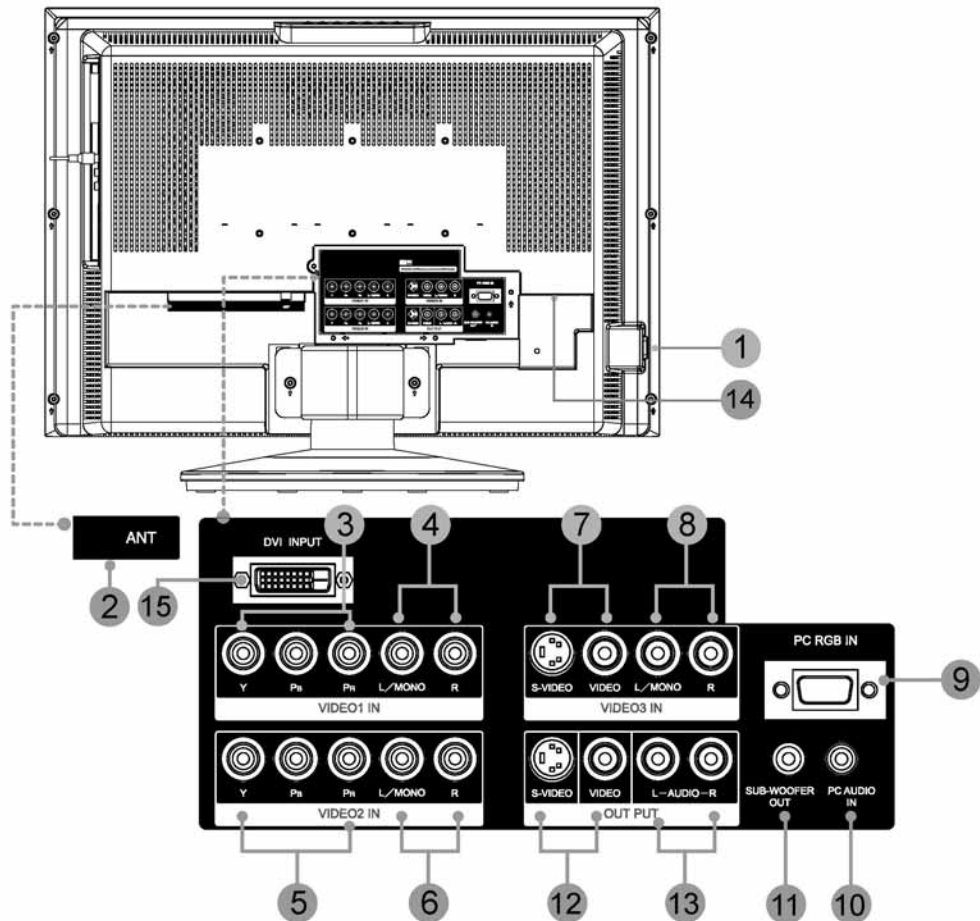

- ① **MAIN POWER button**  
This power button is for the complete system, and must be turned ON/OFF manually. It is recommended to leave the "MAIN POWER" to ON condition (lights red) for stand-by mode.  
**NOTE:** It is required that there should be at least 5 seconds between MAIN POWER button off than on.
- ② **ANTENNA Input**  
Antenna input that connects to the antenna, cable box, or CATV cable. Supports NTSC/PAL/SECAM television system.
- ③ **VIDEO1 Inputs**  
Provide Y-PbPr jacks for connecting equipment with this capability, such as a DVD player or Set Top Box.
- ④ **VIDEO1 Audio Input**  
Connect audio for Y-PbPr input (if you have mono sound, insert the audio cable into the left(L) audio jack).
- ⑤ **VIDEO2 Inputs**  
Provide Y-PbPr jacks for connecting equipment with this capability, such as a DVD player or Set Top Box.
- ⑥ **VIDEO2 Audio Input**  
Connect audio for Y-PbPr input (if you have mono sound, insert the audio cable into the left(L) audio jack).

## REAR PANEL MAIN POWER SWITCH & JACKS

⑦ **VIDEO3**

**S-VIDEO Inputs**

Provide S-VIDEO (Super Video) jacks for connecting equipment with S-VIDEO output capability.

**VIDEO**

By using the VIDEO button of the remote control, you can select Video source. Use the audio and video inputs to connect external devices, such as VCRs, camcorders, laserdisc players, DVD players etc. (if you have mono sound, insert the audio cable into the left(L) audio jack).

⑧ **VIDEO3 Audio Input**

Connect audio for VIDEO/ S-Video input (if you have mono sound, insert the audio cable into the left (L) audio jack).

⑨ **PC RGB In**

Use this 15-pin D-Sub input for your external devices with RGB output.

⑩ **PC Audio In**

Connect audio for PC RGB input.

⑪ **SUBWOOFER Out**

Connect this SUB WOOFER OUT output to the external audio component input.

⑫ **S-VIDEO/VIDEO OUTPUT**

These jacks provide video signals (NTSC, PAL, SECAM) which are used for recording.

⑬ **AUDIO Output**

These jacks provide fixed audio signal which are used for recording.

**S-VIDEO/VIDEO TABLE :**

(a) Normal mode:

Input \ Output	S-VIDEO	VIDEO	AUDIO
ANT	×	○	○
VIDEO1 /VIDEO2	×	×	○
VIDEO3 /VIDEO4	○	○	○
ANALOG RGB	×	×	○
DVI	×	×	○

(b) For POP/PIP mode:

The VIDEO output is according to user's selected source, the speaker's position.

The output table should be the same with the above table.

⑭ **AC IN**

This television is designed to operate on 100-240 VOLTS 50/60Hz AC current. Insert the TV power cord into a 100-240 VOLTS 50/60Hz outlet.

⑮ **DVI -INPUT**

Stand for Digital Visual Interface. Use for high quality PC display.



## SIDE PANEL CONTROLS

### SIDE VIEW

26" LCD Television

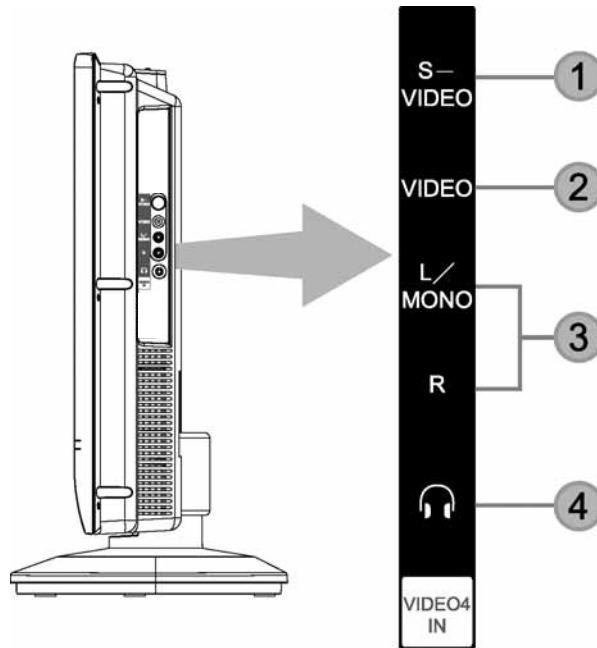

#### VIDEO 4

##### ① S-VIDEO Inputs

Provide S-VIDEO (Super Video) jacks for connecting equipment with S-VIDEO output capability.

##### ② VIDEO Input

By using the VIDEO button of the remote control, you can select Composite video source. Use the audio and video inputs to connect external devices, such as VCRs, camcorders, laserdisc players, DVD players etc. (if you have mono sound, insert the audio cable into the left(L) audio jack).

##### ③ Audio Input

Connect audio for VIDEO/ S-Video input (if you have mono sound, insert the audio cable into the left(L) audio jack).

##### ④ HEADPHONE JACK OUTPUT

Connect to the Headphone.

## CONNECTING EXTERNAL SOURCES

The exact arrangement you use to connect the PC, VCR, camcorder, laserdisc player, DVD player, or HDTV Set Top Box to your LCD television is dependent on the model and features of each component. Check the owner's manual of each component for the location of video and audio inputs and outputs.

The following connection diagrams are offered as suggestions. However, you may need to modify them to accommodate your particular assortment of components and features. For best performance, video and audio cables should be made from coaxial shielded wire.

ENGLISH

**NOTES:** Refer to the owner's manual of the external equipment to be connected. When connecting external equipment, do not connect the AC power cords to wall outlets until all other connections are completed.

### CONNECTING AN ANALOG TELEVISION CABLE OR AN ANALOG ANTENNA WITHOUT A TV CABLE BOX

1. Use one of the following two diagrams if you connect to an outdoor antenna.

A: Using a VHF/UHF combination outdoor antenna.

B: Using separate VHF and/or UHF outdoor antennas.

2. Connect all power sources before activating the LCD television.

3. Turn on the LCD television.

A

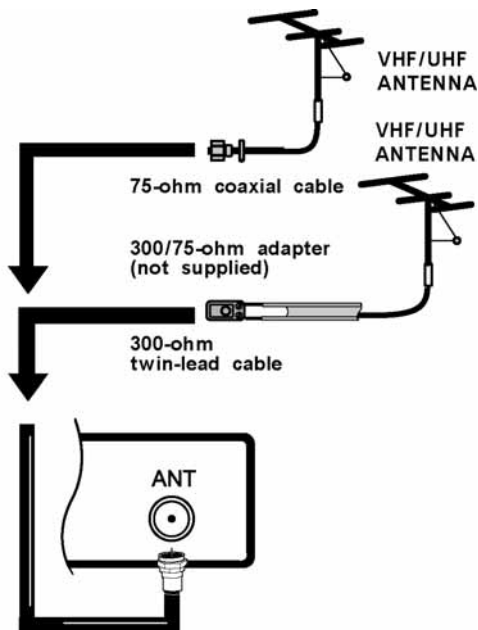

B

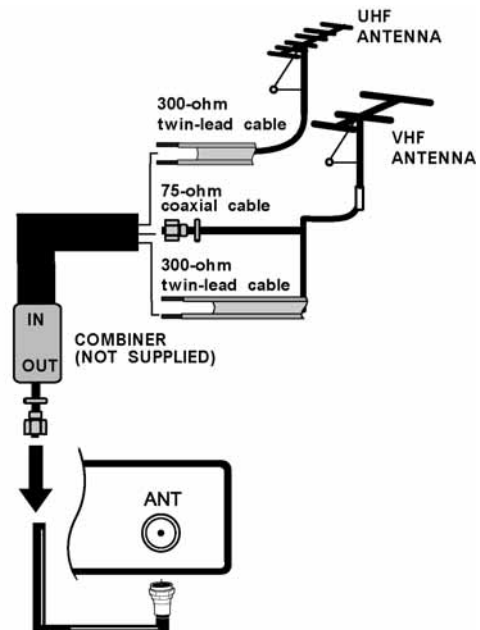

**NOTES:** Ensure that the power cord is inserted correctly to avoid connector damage.  
For safety, install an external antenna conforming to AS1417.1 (applicable for Australia only)

## CONNECTING EXTERNAL SOURCES

- Connect the equipment to the television, making the correct rear panel and side panel connection.
- Before connecting anything :
  - Read the manuals that came with the equipment. Depending on the equipment, the connection method may be different from the diagram. Also, the equipment settings may need to change depending on the connection method.
  - Turn off all the equipment.
  - Connecting cables are not supplied.

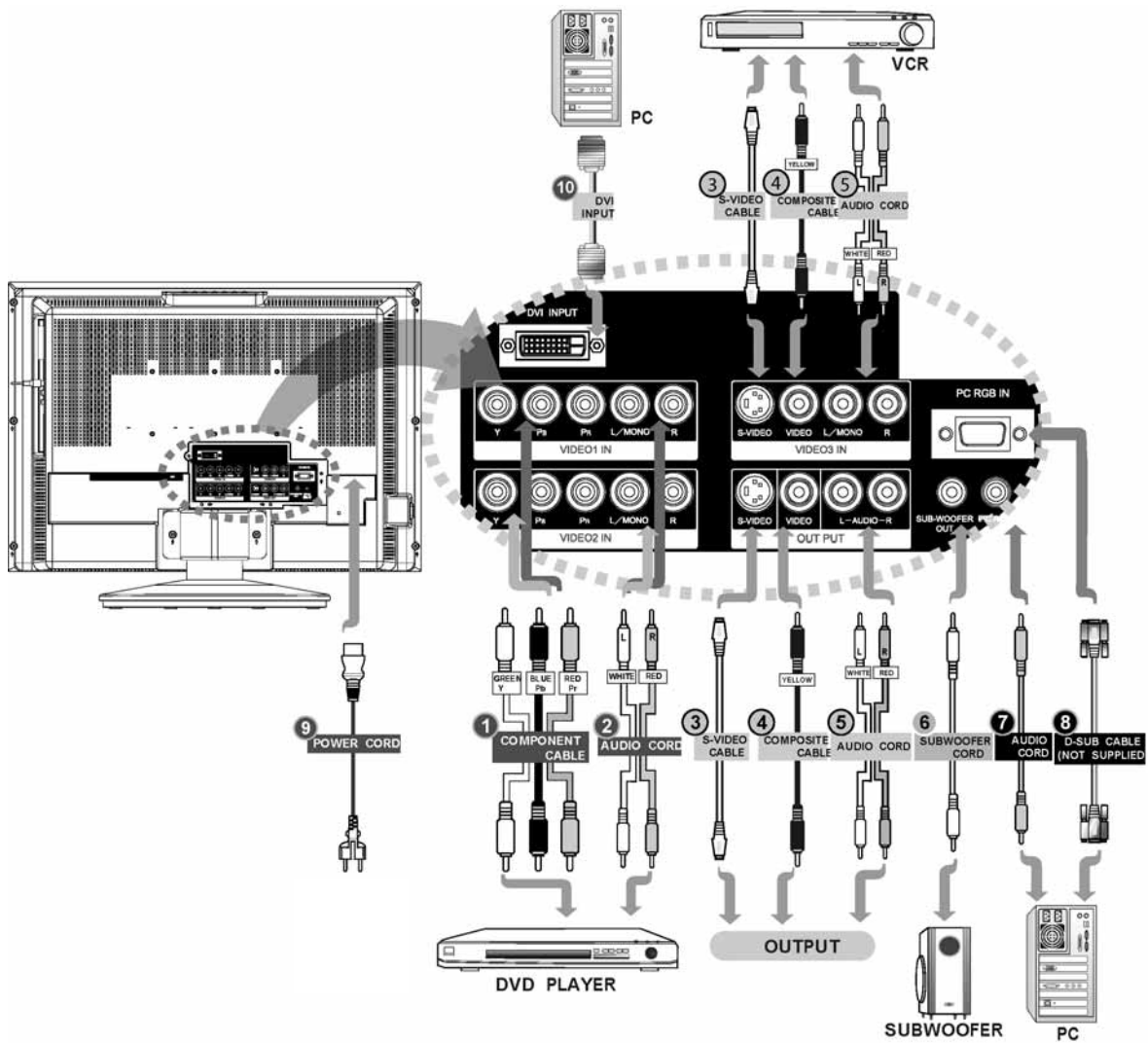

## CONNECTING EXTERNAL SOURCES

- A. DVD player (component / composite / S-VIDEO signal)
- B. Subwoofer
- C. PC
- D. VCR player (composite / S-VIDEO signal)
- E. Camcorder
- F. Headphone

- ① Y-PbPr cable
- ② Audio cable
- ③ S-VIDEO cable
- ④ VIDEO cable
- ⑤ Audio cable
- ⑥ Subwoofer cable
- ⑦ PC Audio cable
- ⑧ PC D-SUB cable
- ⑨ Power cord
- ⑩ DVI Cable

ENGLISH

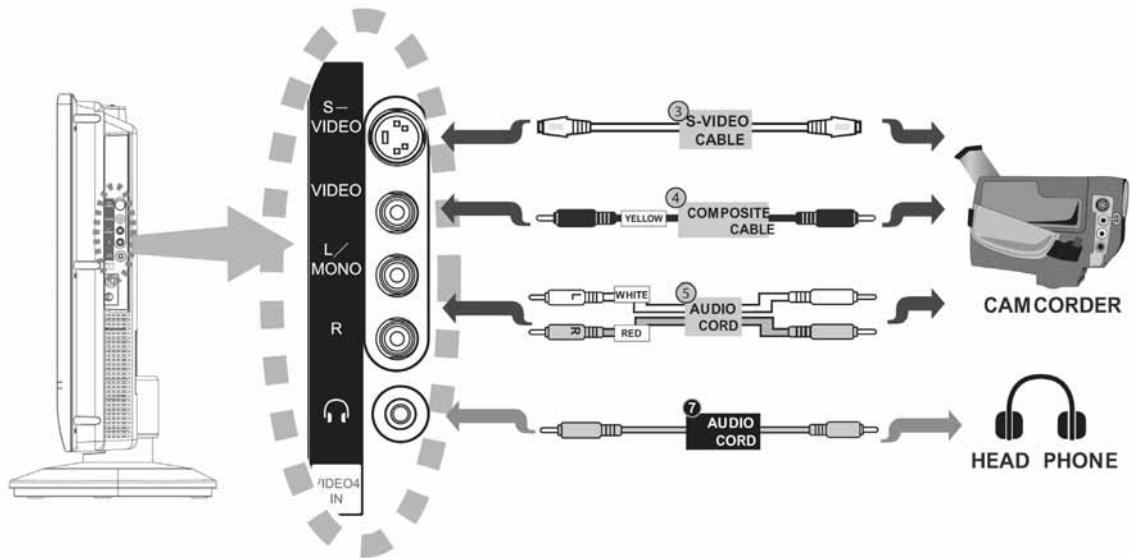

## Remote Control Buttons and Functions

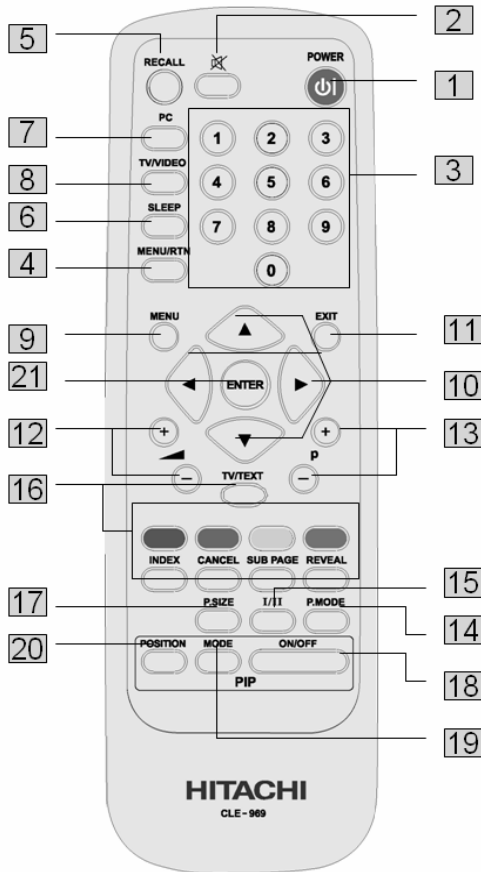

1. Power Button
2. Mute Button
3. Number Buttons
4. MENU /RTN Button
5. Recall Button
6. Sleep Time Button
7. PC Source Button
8. TV/VIDEO Source Button
9. Menu Button
10. Up/Down/Left/Right Button
11. Exit Button
12. Volume (+/-) Button
13. Channel (+/-) Button
14. P. Mode Button
15. I/II Button
16. TeleText Buttons
17. P.Size Button
18. Multi Picture ON/OFF Button
19. Multi Picture Mode change Button
20. PIP Position Button
21. ENTER Button

### Turn the Television On or Off

- Press the  button to turn the television on or standby mode.
- When television is turned on, the power lamp changes from red to green.

### Choose a Television Channel

- Use Number buttons to choose specific channel.

Example:

27 → press 2 and 7





06 → press 0 and 6 or press 6 only

- Use the P +/- buttons to choose the programmed number you want.

NOTE : If you do not have a clear picture or no color appears, change the color system manually.

## Remote Control Buttons and Functions

### Adjust the Volume

- Press the  +/- buttons to adjust the volume.
- The volume indicator appears and the volume changes as you press the  +/- buttons.
- Muting the sound : Press the  (MUTE) button to turn off the sound.
- Press the  (MUTE) again or volume up/down to restore the previous volume level.

### Watch Images from External Equipment

- Use the PC and TV/VIDEO buttons to choose an external terminal.
- Press to access the TV, video1, video2, video3, and video4. Press repeatedly to circle through the selections. Also can press number buttons to switch to antenna mode.

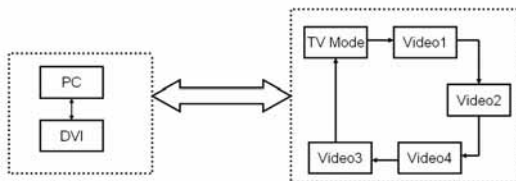

- In PC mode :  
If the following message appears, the power lamp blinks in amber and the television goes in to power saving mode.
  - "NO SYNC SIGNAL"
  - "CABLE NO INSERT"
  - "INVALID SCAN FREQ"

### Displaying the Source Information

- You can display the source information on the screen.
- Press the RECALL button to display the source information, as follows :

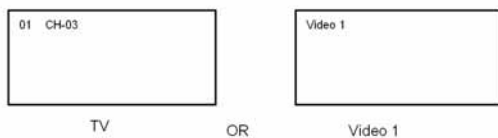









- The source type : TV / VIDEO 1 / VIDEO 2 / VIDEO 3 / VIDEO 4 / PC / DVI

## Remote Control Buttons and Functions

### Aspect Ratio

- You can change the screen size according to the picture aspect ratio. Choose the optimum one from the following zoom modes.

When you want to	Set the display size to	Input signal	Display screen	Remarks
Play a 4:3 image in a 16:9 screen faithfully.	4 : 3	 (4:3 signal)		Blanking occurs on both sides.
Play a 4:3 image in a 16:9 screen with the height and width of the middle of the screen enlarged on equal scales and with both sides appearing somewhat enlarged.	Panoramic			
Play a 16:9 VISTA size image in the 4:3 image faithfully reproduced on the 16:9 screen.	Zoom	 (Vista)		<ul style="list-style-type: none"> <li>The 4:3 image is called a letterbox image.</li> <li>In some cases, some slight blanking may remain at the top and bottom.</li> </ul>
Play a 21:9 Cinema size image in the 4:3 image expanded vertically on the 16:9 screen.	Cinema	 (Cinema)		In some cases, some slight blanking may remain at the top and bottom.
Play a 4:3 image faithfully in a 16:9 screen in the standard vertical size and horizontally squeezed.*	Full	 (Squeeze)		* An image with an aspect ratio of 16:9 shrunk horizontally to 4:3 to display in a 4:3 screen.

- Choose the zoom mode : Press the P.Size button to display the zoom menu.

NOTE : 1.The P.Size button does not work in the multi pictures mode.

2.The size will fix as full mode and not change when receiving the Y-PbPr signal of 1080i/50, 1080i/60, 720p/50, or 720p/60.

### Sleep Timer Function

- The Sleep Timer can turn the television off for you after you fall asleep.
- Press the SLEEP button repeatedly to set the sleep timer to 30, 60, 90, and 120 minutes.

### Picture Mode

- You can choose one of four PICTURE MODES to adjust the picture settings automatically.
- Press P. MODE button to select Dynamic, Nature, Game, and Cinema picture mode. Press repeatedly to circle through the selections.

# Remote Control Buttons and Functions

## POP / PIP FUNCTIONS

- TV, VIDEO and PC pictures can be watched at the same time.
- Press the POP ON/OFF button to turn on/off multi picture function.

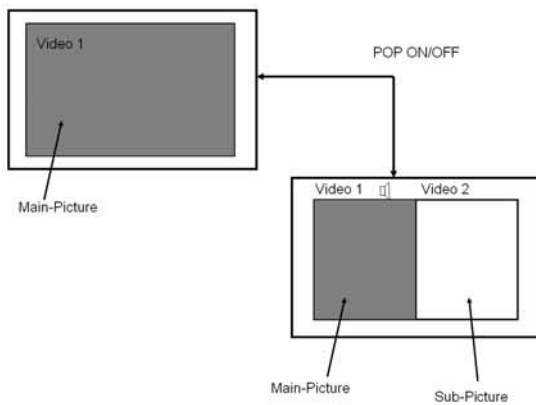

- Press MODE button to select POP and PIP mode.

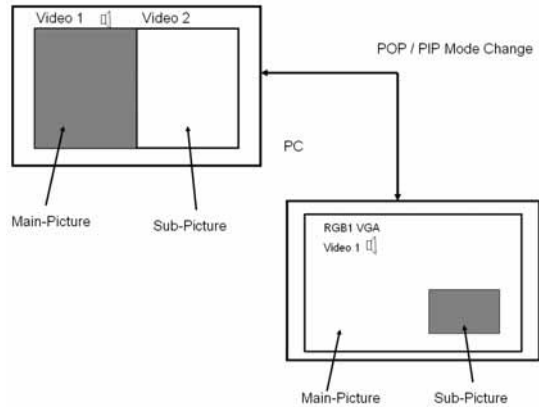

PIP mode support pictures :

POP mode support pictures :

Sub Main	TV	Video 1 (HDTV)	Video 2 (HDTV)	Video 3 (AV/SV)	Video 4 (AV/SV)
TV		✓	✓	✓	✓
Video 1 (HDTV)	✓		✓	✓	✓
Video 2 (HDTV)	✓	✓		✓	✓
Video 3 (AV/SV)	✓	✓	✓		✓
Video 4 (AV/SV)	✓	✓	✓	✓	
PC	✓	✓	✓	✓	✓
DVI	✓	✓	✓	✓	✓

NOTE : You can press ◀/▶ buttons to select which display window will be changed. Meanwhile, the speaker icon will be displayed on selected display window. User can change input video source on selected display window by pressing remote controller TV / VIDEO button.

Sub Main	TV	Video 1 (HDTV)	Video 2 (HDTV)	Video 3 (AV/SV)	Video 4 (AV/SV)
TV					
Video 1 (HDTV)					
Video 2 (HDTV)					
Video 3 (AV/SV)					
Video 4 (AV/SV)					
PC	✓	✓	✓	✓	✓
DVI	✓	✓	✓	✓	✓

NOTE : In PIP mode, Press ▲/▼ buttons to select which display window will be changed. Meanwhile, the speaker icon will be displayed on selected display window. User can change input video source on selected display window by pressing remote controller source keys.



## Remote Control Buttons and Functions

3. Press the POSITION button to change the position of sub picture.

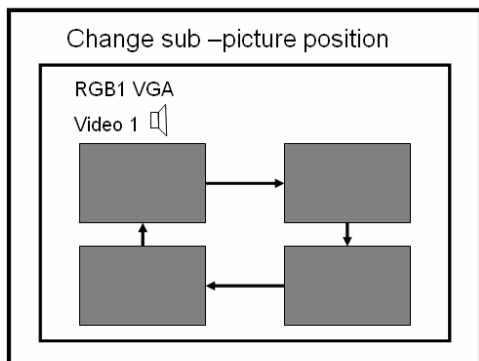

## Teletext Function

### Basic Operation

1. Choose a TV channel with a teletext broadcast.
2. Press TV / TEXT button to display the teletext

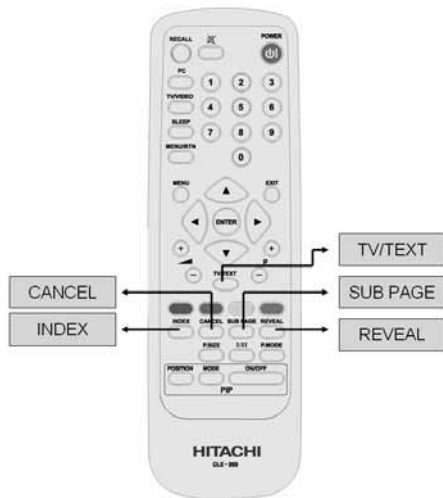

3. Choose a teletext page by pressing color buttons or number buttons.
  - If you have trouble receiving teletext broadcasts, consult your local dealer or the teletext function.
  - The ZOOM function will not work in the TV and text mode or Text mode.
  - You cannot operate menus when viewing a teletext program.
4. To return to the TV mode : Press the TV/Text button.

### INDEX

- You can return to the index page instantly.
- Press the INDEX button : Return to page 100 or a previously specified page.

### CANCEL

You can search for a teletext page while watching TV.

1. Press color button or number button to enter a page.
2. Press the CANCEL button :  
The TV program appears. When the TV finds the teletext page, its page number appears in the upper left of the screen.
3. Press the CANCEL button to return a teletext page when the page number is on the screen.

NOTE: The TV mode cannot be resumed by pressing the CANCEL button. To return to the TV mode press TV/Text button.

### Sub-page

Some teletext pages include sub-pages that are automatically displayed.

1. Choose a teletext page that includes sub-pages.
2. Press the SUB-PAGE button numbers can be viewed and displayed at the screen.
3. Press the number buttons to choose a sub-page number

### Reveal

Some teletext pages include hidden text ( such as the answers to quiz).

You can display the hidden text.

### RED/GREEN/YELLOW/BLUE

Each of these buttons selects a link page displayed at the lower part of the screen.

## OSD (On-Screen Display)

To use all your television's functions, you need to understand the basic menu operating techniques fully.

THERE ARE TWO DIFFERENT MODES FOR THE OSD:

**Video Mode:** Displays when the TV, VIDEO1, VIDEO2, VIDEO3, and VIDEO4 is selected.

**PC Mode:** Displays when the PC RGB input is selected.

---

### Basic Operation

---

1. Press the MENU button to display the MENU(main menu).



2. Use the ▲▼ buttons to choose a menu title, and press the ENTER button.
3. Use the ◀▶ to adjust functions.
4. Press ENTER on the remote control to select functions.
5. Press MENU/RTN on the remote control to return to the previous.
6. Press EXIT on the remote control to quickly exit from a menu.

---

### Operation with the buttons on the TV

---

You can also operate the menus using the buttons on the top panel of the TV.

---

The menu will disappear after about one minutes if no operation is performed.

---

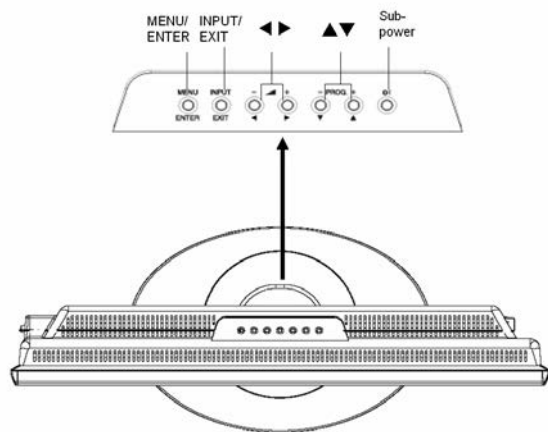
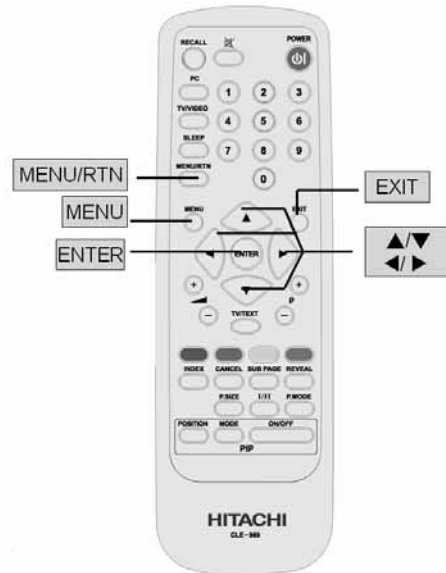

## OSD (On-Screen Display)

### Picture Setting



#### ● Picture mode

You can choose one of the four PICTURE MODES to adjust the picture settings.

They are Dynamic, Natural, Cinema, and Game.

#### ● Picture Adjustment

You can change the picture settings of each PICTURE MODE as you like.

Tint : Adjusts the color properties.

Color : Adjusts the saturation level of color.

Contrast : Adjusts the color brightness of the display.

Brightness : Adjusts the darkness and lightness of the display.

Sharpness : Adjusts the clarity of images.

Backlight : Adjusts the backlight.

Color Temperature : Adjusts the level of the color temperature. (High/Low)

Reset : You can reset the picture settings you have chosen to the default settings in case of COLOR TEMPERATURE

### Sound Setting



#### ● Sound Adjustment

You can adjust the sound to your liking.

Bass : Increases and decreases the level of bass.

Treble : Increases and decreases the level of treble.

Balance : Adjusts the left and right sound level.

SRS WOW : Turns SRS WOW function on and off.

Subwoofer : Turns subwoofer function on and off.



SRS WOW is an audio enhancement technology from SRS Labs that provides deep, rich bass on any speaker system without the need for a subwoofer or additional extra physical components. For systems with a subwoofer, SRS WOW complements and enhances the bass performance. This feature can be set to On or Off.

**NOTES:** WOW, SRS and the  symbol are trademarks of SRS Labs, Inc. SRS WOW technology is incorporated under license from SRS Labs, Inc.

## OSD (On-Screen Display)

### Initial Setup

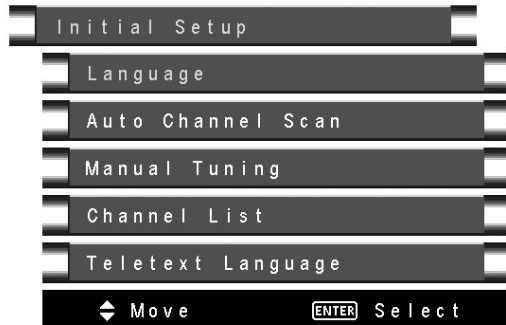

#### ● Language



Select LANGUAGE and press ▲/▼ buttons to choose the language.

They are English, Traditional Chinese, Simplified Chinese, Japanese and Russian.

#### ● Auto Channel Scan



In auto channel scan, the TV automatically scans through all available channels.

Select **START** and press ENTER button to start channel scanning.



The AUTO SCANNING menu appears and the received TV channels are automatically stored in the channel list.

To cancel the AUTO CHANNEL SCAN function, press the EXIT button.

After scanning, the CHANNEL LIST menu appears.

You can edit the channel number using the CHANNEL LIST, for details please see page 29.

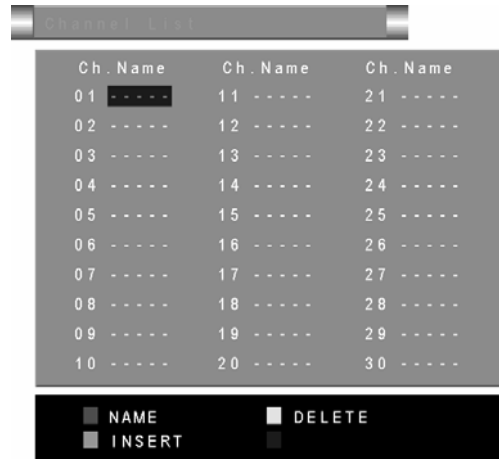

#### ● MANUAL

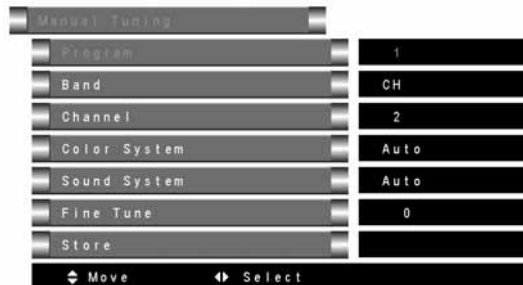

You can store the TV channel that you need in the TV's channel list by setting the following.

Program : Select PROGRAM and press the ◀/▶ buttons to choose the programmed number from 00 to 99.

Band : Select BAND and press the ◀/▶ buttons to choose the band type. ( CH-AIR / CC-CATV)

Channel : Select CHANNEL and press the ◀/▶ buttons to choose the channel number. (CH:02-69, CC:01-99)

Color System : Select COLOR SYSTEM and press the ◀/▶ buttons to choose the color system. (AUTO/PAL/SECAM)

## OSD (On-Screen Display)

(NOTE : If you do not have a clear picture or no color appears, please change the color system.)

Sound System : Select SOUND SYSTEM and press the ◀▶ buttons to choose the sound system.(AUTO/B/G/ D/K I)

(NOTE : If the SOUND SYSTEM setting for a TV channel is incorrect, it may proven the sound from being issued.)

Fine Tune : If the channel reception is poor, select FINE TUNE and press the ◀▶ buttons to fine tune the program.

Store : Select STORE and press the ◀▶ buttons to store the manual setting. When stored, OK will be displayed for a few seconds.

### ● Channel List

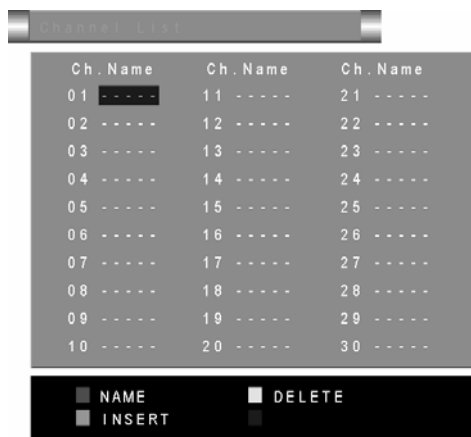

Using the NAME, DELETE, or INSERT functions rewrites the current programmed numbers list.

Therefore, the programmed number of some of the TV channels will change.

Follow the operation description of a function you want to use and operate the function.

Name : This function registers a channel name (ID) to a TV channel.

Insert : This function changes a programmed number of a TV channel.

Delete : This function deletes a TV channel you do not want to list.

### NAME

1. Press the ▲/▼ and ◀▶ buttons to choose a TV channel  
Every time you press the ▲/▼ and ◀▶ buttons, the programmed number changes and the picture of the TV channel stored in the programmed number appears on the screen.
2. Press the red button to start the NAME function.



3. Press the ▲/▼ and ◀▶ buttons to edit the channel name for the TV channel.

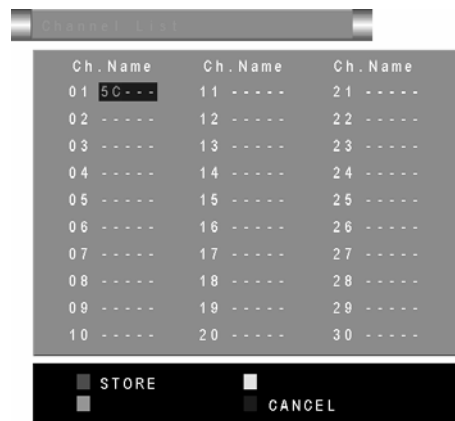

## OSD (On-Screen Display)

- Press the red button to store the setting.

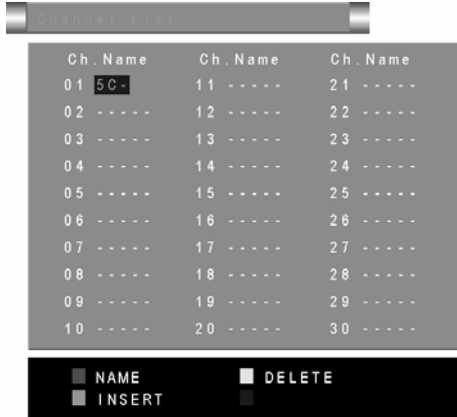

To return to the INITIAL SETUP menu : Press the RETURN button.

To exit a menu instantly : Press the EXIT button.

### INSERT

- Press the ▲/▼ and ◀/▶ buttons to choose a program number which you want.  
Every time you press the ▲/▼ and ◀/▶ buttons, the programmed number changes and the picture of the TV channel stored in the programmed number appears on the screen.

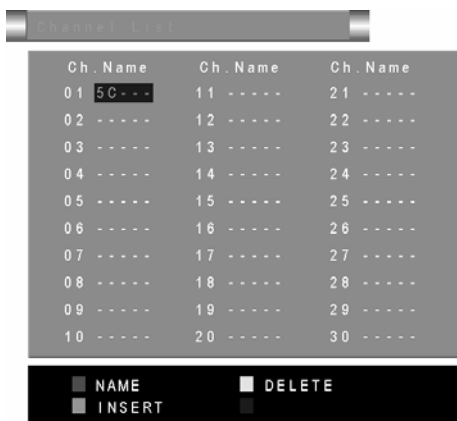

- Press the green button to start the INSERT function.

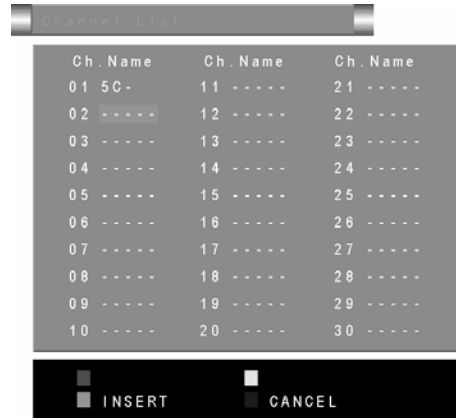

- Press the ▲/▼ and ◀/▶ buttons to choose a new program number.

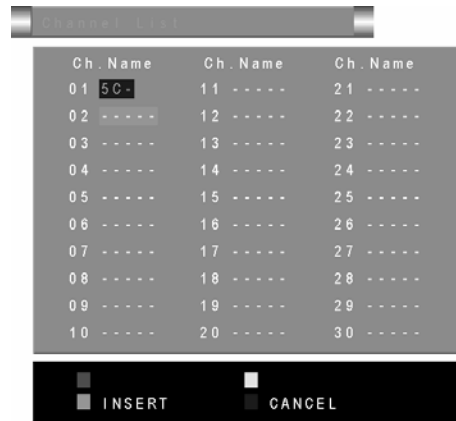

- Press the green button to insert the channel into the new program number.

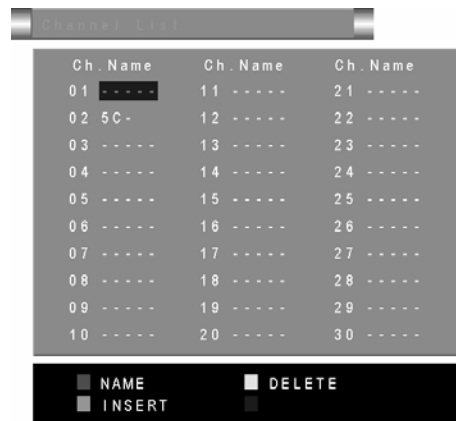

To return to the INITIAL SETUP menu : Press the RETURN button.

To exit a menu instantly : Press the EXIT button.

## OSD (On-Screen Display)

### DELETE

1. Press the ▲/▼ and ◀/▶ buttons to choose a TV channel  
Every time you press the ▲/▼ and ◀/▶ buttons, the programmed number changes and the picture of the TV channel stored in the programmed number appears on the screen.

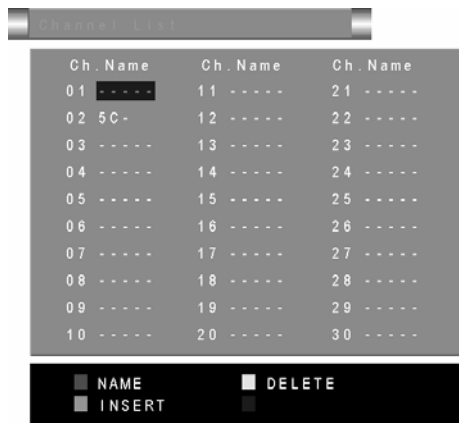

2. Press the blue button to start the DELETE function.
3. Press the ▲/▼ and ◀/▶ buttons to select the channel name you want to delete.

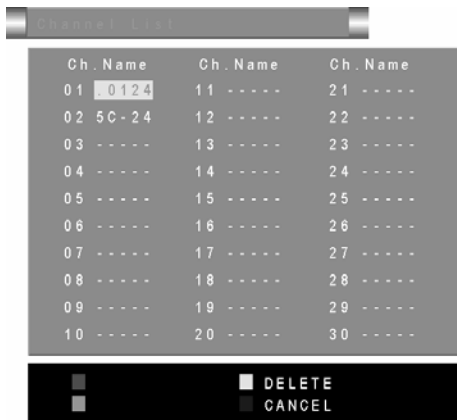

4. Press the blue button to store the setting.

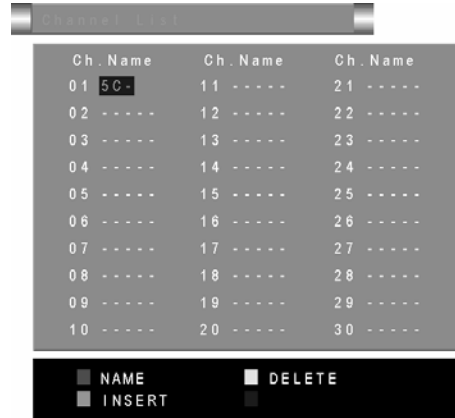

To return to the INITIAL SETUP menu : Press the RETURN button.

To exit a menu instantly : Press the EXIT button.



## OSD (On-Screen Display)

- **Teletext**

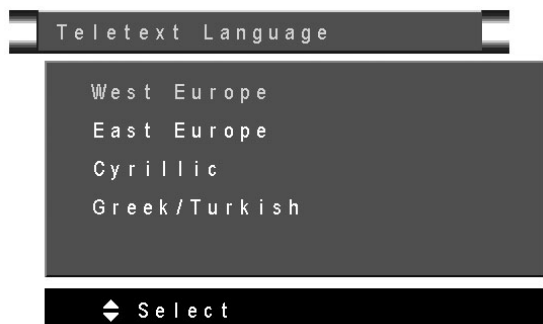

Press the ▲/▼ buttons to choose a teletext language.

Select the teletext language, depending on the area utilized, through the 4 settings:

West Europe, East Europe, Cyrillic and Greek/Turkish.

## OSD (On-Screen Display)

### 26LD8000TA 2 / PC Supported Mode List

Mode No.	Mode Name Resolution	H. Freq. (kHz) V. Freq. (HZ)
1.	VGA 60HZ 640 x 480	31.469 59.941
2.	SVGA 56HZ 800 x 600	31.156 56.25
3.	SVGA 60HZ 800 x 600	37.879 60.317
4.	XGA 60HZ 1024 x 768	48.363 60.004
5.	WXGA 1280 x 768	47.73 60

### DVI support timing

Mode No.	Mode Name Resolution	H. Freq. (kHz) V. Freq. (HZ)
1.	VGA 60HZ 640 x 480	31.469 59.941
2.	SVGA 60HZ 800 x 600	37.879 60.317
3.	XGA 60HZ 1024 x 768	48.363 60.004
4.	WXGA 1280 x 768	47.73 60
5.	480i	15.73 59.94
6.	480p	31.47 59.94
7.	1080i	33.75 60.00
8.	720p	45.00 60.00
9.	576i	15.63 50.00
10.	576p	31.47 50.00
11.	1080i/50	28.13 50.00
12.	720p/50	44.96 50.00

- The Auto SETUP function will work automatically when you change the resolution of PC mode. The picture position, clock, and phase will be optimized.

- Whenever your LCD-TV is connected to the PC, or you have changed the PC display mode. Please use AUTO SETUP to automatically configure your display to the best settings.
- You must perform auto setup before making any adjustment.

ENGLISH

This TV also has a number of functions on PC mode, you can operate using PC menus.



### PC Picture Position

You can adjust the picture settings as following functions.

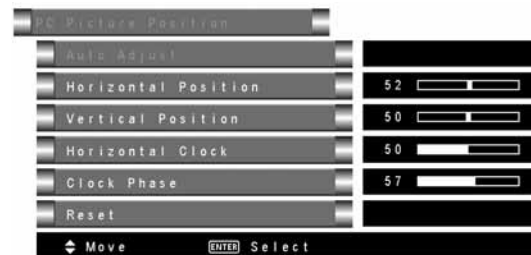

#### ● Picture Position Adjustment

Auto Adjust : You can adjust picture settings automatically for optimized picture position, clock, and phase.

Horizontal Position : You can adjust picture horizontal position.

Vertical Position : You can adjust picture vertical position.

Horizontal Clock : You can adjust CLOCK to fine tune picture.

Clock Phase : You can adjust PHASE to fine tune picture.

Reset : You can select RESET mode for default setting.

## OSD (On-Screen Display)

### PC PICTURE

You can change the picture settings of each PICTURE MODE as you like.

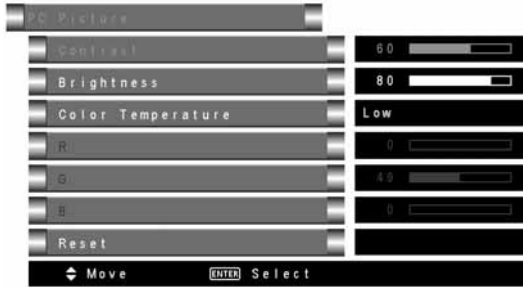

#### ● Picture Adjustment

Contrast : You can adjust the contrast.

Brightness : You can adjust the backlight.

Color Temperature : You can adjust the picture color mode.

(High / Low / Manual)

(NOTE : When COLOR TEMPERATURE is set at HIGH and LOW, R,G,B bars are in gray and can not be adjusted.

R : You can adjust the Red color component.

G : You can adjust the Green color component.

B : You can adjust the Blue color component.

Reset : You can select RESET mode for default setting.

### AUDIO

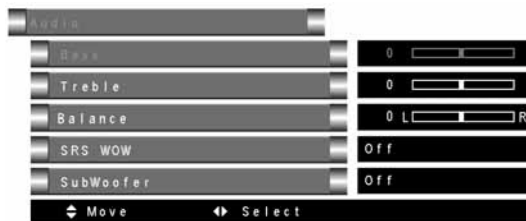

#### ● Sound Adjustment

You can adjust the sound to your liking.

Bass : Increases and decreases the level of bass.

Treble : Increases and decreases the level of treble.

Balance : Adjusts the left and right sound level.

SRS WOW : Turns SRS WOW function on and off.

Subwoofer : Turns subwoofer function on and off.

## Self Diagnosis Function

If a problem arises while you are using the television, please read this self diagnosis function guide carefully before you ask to have the television repaired. You may be able to fix it easily by yourself. For example, if the mains plug is disconnected from the mains outlet, or the television aerial has problems, you may think there is a problem with the television itself.

### Important:

- This self diagnosis function guide only covers problems with causes that are not easy to decide. If you have a question when you are operating a function, read the page(s) for that function carefully, not this self diagnosis function guide.
- If you follow the advice in this self diagnosis function guide without any success, unplug the mains plug and ask your television to be repaired. Do not attempt to repair the television by yourself or to remove the rear cover of the television.

### If you cannot turn on the TV:

- Are the AC plug on the power cord from the television connected to AC outlet?

### Poor picture:

- If noise totally blocks out the picture, there may be a problem with the aerial or the aerial cable. Check the following to try to solve the problem:
  - Have the television and aerial been connected properly?
  - Has the aerial cable been damaged?
  - Is the aerial pointing in the right direction?
  - Is the aerial itself faulty?
- If the television or aerial suffers interference from other equipment, stripes or noise may appear in the picture. Move any equipment such as an amplifier, personal computer, or a hair dryer, that can cause interference away from your television. Or try moving the television. If the aerial suffers interference from a radio tower or high-voltage wire, please contact your local dealer.
- If the television suffers interference from signals reflecting from mountains or buildings, double-pictures(ghosting) will occur. Try to change the aerial's direction or replace it with one with better directionality.
- Have the COLOR and BRIGHTNESS settings been adjusted properly? Follow the description "PICTURE ADJUSTMENT" to try to adjust them properly.
- Videotaping teletext is not recommended because it may not record correctly.
- When viewing images from commercially available video software products, or videos from video tapes which have been recorded improperly, the top of the image may be distorted. This is due to the condition of the video signal. There is nothing wrong with the television.

### Poor sound:

- Have you adjusted BASS or TREBLE properly? If not, follow the description "SOUND ADJUSTMENT".

### If the TV does not respond to the remote control:

- Have the batteries of the remote control worn out? Follow the description "PUTTING THE BATTERIES INTO THE REMOTE CONTROL" and replace them with new batteries.
- Have you attempted to use the remote control from the sides or rear of the television or from more than seven meters away from the television? Use the remote control in the front of your television or from less than seven meters away.
- If the television suddenly stops responding, disconnect the power cord of the television from the AC outlet. Connect them to the AC outlet again to turn on the television. If the television returns to a normal state, it is not a failure.

## Self Diagnosis Function

### Other concerns:

- When the SLEEP TIMER function operates, the television is automatically turned off. If the television suddenly turns off, try to press the standby button to turn on the television once again. If the television goes back to normal, there is no problem.
- It takes a short period of time from the time an operation such as changing channels is performed until an image is displayed. This is not a malfunction. This is the time required for the image to stabilize it can be displayed.
- The television may make a crackling sound due to a sudden change in temperature. The picture or sound may be normal. If you hear crackling sounds frequently while you are viewing the television, there may be other causes. As a precaution, ask your service technician to inspect it.
- The top of the television and the screen may become hot during use but this has no effect on the performance of the television. Ensure that the ventilation holes are not blocked.
- When the picture is unstable, the screen may become white for a moment. This occurs when the signal which drives the liquid crystal is missing. This is not a malfunction.
- When a still image has been displayed for a long period, a faint residual image may remain on the screen for a short time after the power has been turned off or when another image is displayed. This is not a malfunction and the image will eventually disappear.

Item \ Model	26LD8000TA 2	
Brocadcasting system	PAL(I, D/K, B/G) , SECAM(D/K, B/G), NTSC M	
Color system	PAL, NTSC 4.43, NTSC 3.58, SECAM	
Channels and frequencies	<ul style="list-style-type: none"> <li>● E2-E12, E21-E69, S1-S41, X, Y, Z+1,Z+2, ITALY A-H, ITALY H+1, ITALY H+2, F2-F10, F21-F69,R1-R12, R21-R69, IR A-J</li> <li>● French cable TV channel of broadcast frequencies 116-172 MHz and 220-469 MHz</li> </ul>	
Sound-multiplex systems	A2(B/G, D/K), NICAM(B/G, I, D/K) system	
Teletext systems	FLOF (Fastext), WST (World Standard System)	
Power requirements	AC adapter : 100-240V AC, 50/60 Hz	
Power consumption	120W, standby < 1W	
Screen size	Viewable area 66.1cm (measured diagonally)	
Display resolution	1366 (H) x 768 (V) pixels	
Audio output	Rated Power output : 10W + 10W	
Speakers	4 ohm, 10 W x2	
VIDEO-1 terminal	Component Video(Y, Pb, Pr) input and Audio L/MONO and R inputs are available	
VIDEO-2 terminal	Component Video(Y, Pb, Pr) input and Audio L/MONO and R inputs are available	
VIDEO-3 terminal	Video input, S-VIDEO (Y/C) input and Audio L/MONO and R inputs are available	
VIDEO-4 terminal	Video input, S-VIDEO (Y/C) input and Audio L/MONO and R inputs are available	
VIDEO OUTPUT terminal	TV, Video onput, S-VIDEO (Y/C) output and Audio L/MONO and R output are available	
PC IN terminal	Analog RGB : D-SUB(15pins) x 1, PC AUDIO In x 1 PC signal and audio inputs are available	
DVI	DVI-D, 24pins	
AUDIO OUT terminal	RCA connector x 3, Audio L/R outputs , and subwoofer output are available,	
Headphone jack	Stereo mini-jack (3.5mm in diameter)	
Dimensions (W x H x D)	661.9 (W) x 522.5 (H) x 267(D) mm (With Base) 661.9 (W) x 463 (H) x 103(D) mm (Without Base)	
Weight	17.5 kg (With Stand) 15 kg (Without Stand)	
Accessories	Remote control unit x1 AAA, 1.5V batteries dry cell battery x 2 Power cord x1 User's manual x1	
Ambient conditions	Temperature	Operating:5°C to 35°C, Storage : 0°C to 40°C
	Relative humidity	Operating:20% to 80%, Storage : 20% to 90%(non-condensing)

ENGLISH

## PRODUCT SPECIFICATIONS (continued)

### Signal Input

#### RGB terminal (D-sub 15-pin connector)

Pin	Input signal
1	R
2	G
3	B
4	No connection
5	No connection
6	R.GND
7	G.GND
8	B.GND
9	No connection
10	GND
11	No connection
12	[SDA]
13	H. sync
14	V. sync
15	[SCL]

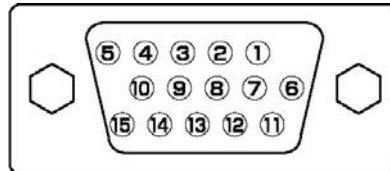

- When different kinds of input signals are simultaneously input to the monitor via a graphics board or the like, the monitor will automatically select the signals in the following priority order:

#### S-input connector pin specifications

Pin	Input signal
1	Y
2	Y-GND
3	C
4	C-GND
Frame	GND

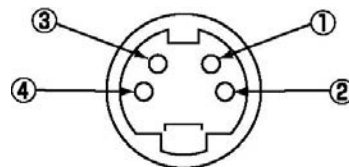

## PRODUCT SPECIFICATIONS (continued)

### Signal Input

#### DVI terminal (DVI-D)

Pin	Input signal	Pin	Input signal
1	T.M.D.S. Data2-	14	+5V Power
2	T.M.D.S. Data2+	15	Ground (for+5V)
3	T.M.D.S. Data2/4 Shield	16	Hot Plug Detect
4	T.M.D.S. Data4-	17	T.M.D.S. Data0-
5	T.M.D.S. Data4+	18	T.M.D.S. Data0+
6	DDC Clock	19	T.M.D.S. Data0/5 Shield
7	DDC Data	20	T.M.D.S. Data5-
8	No Connect	21	T.M.D.S. Data5+
9	T.M.D.S. Data1-	22	T.M.D.S. Clock Shield
10	T.M.D.S. Data1+	23	T.M.D.S. Clock+
11	T.M.D.S. Data1/3 Shield	24	T.M.D.S. Clock-
12	T.M.D.S. Data3-	Frame	GND
13	T.M.D.S. Data3-		

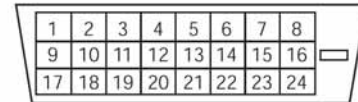

ENGLISH



## PRODUCT SPECIFICATIONS (continued)

### Signal Input

Applicable video signals for input terminal (TV mode)

Terminal	RCA/S-video			D-sub
	CVBS	S-video	Component	RGB
AV1			o	
AV2			o	
AV3	o	o		
AV4	o	o		
PC RGB				o

With composite input(AV3~AV4 input) and S-video input (AV3, AV4 input).

NO.	Signal mode			Horizontal Frequency (kHz)
	Signal Name	Resolution	Vertical frequency (Hz)	
1	NTSC4.43 NTSC3.58	525	59.94	15.73
2	PAL SECAM	625	50.00	15.63

With component input (AV1, AV2 input).

NO.	Signal mode			Horizontal Frequency (kHz)
	Signal Name	Resolution	Vertical frequency (Hz)	
1	576i	576	50.00	15.63
2	480i	480	59.94	15.73
3	576p	576	50.00	31.26
4	480p	480	59.94	31.47
5	1080i/50	1080	50.00	28.13
6	1080i/60	1080	60.00	33.75
7	720p/60	720	60.00	45.00
8	720p/50	720	50.00	37.50

## PRODUCT SPECIFICATIONS (continued)

### Signal Input

With Analog signal input (RGB input)

Mode No.	Mode Name Resolution	H. Freq. (kHz) V. Freq. (HZ)	H. Polarity V. Polarity	Pixel Clock (MHz)	H. Total (Clock)	H. Active (Clock)	H. Back Porch (Clock)	H. Sync. Width (Clock)	V. Total (Line)	V. Active (Line)	V. Back Porch (Line)	V. Sync Width (Line)
1.	VGA 60HZ 640 x 480	31.469 59.941	- -	25.175	800	640	48	96	525	480	33	2
2.	SVGA 56HZ 800 x 600	31.156 56.25	+ +	36.0	1024	800	128	72	625	600	22	2
3.	SVGA 60HZ 800 x 600	37.879 60.317	+ +	40.0	1056	800	88	128	628	600	23	4
4.	XGA 60HZ 1024 x 768	48.363 60.004	- -	65.0	1344	1024	160	136	806	768	29	6
5.	WXGA 1280 x 768	47.73 60	- -	80	1676	280	198	136	795	768	23	3

ENGLISH

## PRODUCT SPECIFICATIONS (continued)

### Signal Input

#### DVI Signal Input

Mode No.	Mode Name Resolution	H. Freq. (kHz)
		V. Freq. (HZ)
1.	VGA 60HZ 640 x 480	31.469
		59.941
2.	SVGA 60HZ 800 x 600	37.879
		60.317
3.	XGA 60HZ 1024 x 768	48.363
		60.004
4.	WXGA 1280 x 768	47.73
		60
5.	480i	15.73
		59.94
6.	480p	31.47
		59.94
7.	1080i	33.75
		60.00
8.	720p	45.00
		60.00
9.	576i	15.63
		50.00
10	576p	31.47
		50.00
11.	1080i/50	28.13
		50.00
12.	720p/50	44.96
		50.00