

HOW TO USE

日立多門電冰箱 REFRIGERATOR-FREEZER

家庭用 For household use

| | | | | |
|-------------|--|--|---|--|
| 型號 Model | R-X730GS R-X730GH R-X730GM R-X730GA | R-X670GS R-X670GH R-X670GN R-X670GM | R-G670GS R-G670GH R-G670GND R-G670GN R-G670GM R-G670GA | R-G620GS R-G620GH R-G620GM R-G620GA |
|-------------|--|--|---|--|



日本製 Made in Japan

六門 6 doors

Thank you very much for purchasing a Hitachi Refrigerator.
This refrigerator is designed for home use only. Do not use this refrigerator for the business use and/or any purpose other than storing food. Please read this operation manual carefully and ensure you use the appliance correctly. In particular, be sure to read the “Safety Suggestions” section of this operation manual before use. Please keep this operation manual along with your guarantee card.
Hand over this operation manual together with the refrigerator when the refrigerator is passed to a third party and used in a different location, or when it is sent to a recycling plant.

● **It takes time to cool for the first time.** →Pg.48, 49

It may take more than 4 ~ 24 hours to fully cool.

● **Make sure that no food protrudes beyond the storage height limit of each compartment, and allow clearance between each food in each compartment.** →Pg.58, 60

Otherwise, food and/or package may not be stored in each compartment properly, and as a result, the door may not be closed completely. It may cause the refrigerator not to cool sufficiently and/or not to make ice.

CONTENTS

BEFORE USE

| | |
|---|-----------|
| SAFETY SUGGESTIONS | 42 |
| LEARN NAME & FUNCTION OF EACH PART ... | 46 |
| Name of each compartment/Food stored | 46 |
| Functions of the Control Panel | 47 |
| BEFORE USE | 48 |
| Preparation before use | 48 |
| Transporting your refrigerator (transport for moving) ... | 49 |

GENERAL USE

| | |
|---|-----------|
| Auto Door | 50 |
| Setting the Auto Door | 50 |
| Using the Auto Refrigerator Door | 51 |
| Using the Auto Drawer | 51 |
| REFRIGERATOR COMPARTMENT | 52 |
| Adjusting temperature in a refrigerator compartment ... | 52 |
| Adjust the height of a pocket/shelf | 53 |
| VACUUM COMPARTMENT | 54 |
| When opening/closing the door of the Vacuum Case ... | 54 |
| Change the settings of the Vacuum Compartment ... | 55 |
| ICE COMPARTMENT (AUTOMATIC ICE MAKER) ... | 56 |
| How to make Ice | 56 |
| Quick Ice Making | 57 |
| Stop Ice Making | 57 |
| Stored ice amount and ice-making time | 57 |
| Water Supply indicator | 57 |
| When the "On" indicator lamp blinks | 57 |
| FREEZER COMPARTMENT | 58 |
| Using the Upper Freezer | 58 |
| Using the Lower Freezer | 58 |
| Caution on how to store foods | 58 |
| Adjust the temperature of the freezer compartment ... | 58 |
| Using the Delicious Freezing | 59 |
| Setting the Delicious Freezing | 59 |
| When you want to freeze food quickly (Quick Freezing) | 59 |
| VEGETABLE COMPARTMENT | 60 |
| Stored foods | 60 |
| Caution on how to store foods | 60 |
| To cool it more [Vegetable Compartment (MAX)] | 61 |
| VARIOUS FUNCTIONS | 62 |
| Setting "Energy Saving" mode | 62 |
| "eco" Operation indicator lamp | 62 |
| Door Open & Close indicator lamp | 62 |
| Locking the Control Panel | 63 |
| Door Alarm | 63 |
| Door Alarm and volume adjustment of the operation sound ... | 63 |
| Set the condensation prevention heater to MIN. (Swing partition) ... | 64 |
| Fine adjustment of the temperature (Refrigerator Compartment / Freezer Compartment) | 65 |
| Triple Power Deodorizing Effect | 65 |

MAINTENANCE

| | |
|--|-----------|
| MAINTENANCE | 66 |
| Power plug/The back/floor of the refrigerator | 66 |
| Vacuum Compartment | 66 |
| Auto Drawer | 67 |
| Surface of door/Each shelf/pocket/case/ Door gaskets/Liquid receivers | 67 |
| Ice Maker Cleaning | 68 |
| Water supply container/Ice tray | 69 |
| HOW TO REMOVE/ATTACH PARTS | 70 |
| Height adjustable upper and middle shelf | 70 |
| Door pocket | 70 |
| Fixed shelf | 70 |
| Height adjustable lower shelf | 70 |
| Vacuum Case | 70 |
| Ice Case (Ice Compartment) • Upper Freezer case (Upper Freezer) ... | 71 |
| Slide case and lower freezer case (Lower Freezer) | 71 |
| Upper Case, Lower Case (Vegetable Compartment) | 71 |
| How to attach the slide door (Ice Compartment/Upper Freezer/ Lower Freezer/Vegetable Compartment) | 71 |

TROUBLESHOOTING



| | |
|--|-----------|
| TROUBLESHOOTING | 72 |
| Initial stage | 72 |
| Control Panel | 72 |
| Automatic ice making | 72 |
| Refrigerator does not cool | 73 |
| Frost and/or dew occurs | 73 |
| Refrigerator cools overly | 73 |
| [] display on the control panel flashes | 73 |
| Abnormal operating sound is generated | 74 |
| Door is not in a horizontal state | 74 |
| Refrigerator becomes hot | 74 |
| There is something strange with the Vacuum Compartment ... | 74 |
| It smells strange | 75 |
| Auto Refrigerator Door | 75 |
| Auto Drawer | 75 |
| Vegetable Compartment | 76 |
| Others | 76 |
| AVAILABLE PARTS | 77 |
| ABOUT NON-CFC REFRIGERATORS/ STORABLE WEIGHT | 79 |

SAFETY SUGGESTIONS



Ensure to follow these precautions

When using this appliance, failure to follow safety precautions may result in personal harm, harm to other people, and also damage to property.

■ The following pictographs categorize and explain the level of possible harm or damage that may occur from ignoring suggestions resulting in missing the appliances.

| | | |
|---|----------------|---|
|  | WARNING | Suggestions headed by this pictograph indicate "There is high chance of serious injury or death" if ignored. |
|  | CAUTION | Suggestions headed by this pictograph indicate "There is a high chance of injury or damage to property" if ignored. |

■ How the suggestions should be taken are indicated and categorized by the following symbols accompanied by explanations. (The symbols below are examples)

| | |
|---|---|
|  | This symbol indicates something you must not do. (Prohibited) |
|  | This symbol indicates something you must do. (Compulsory) |

■ This refrigerator uses flammable refrigerants. The symbol column below states the precautions on flammable refrigerants.

 This symbol denotes the precautions on flammable refrigerants.

R600a

⚠ WARNING

Installation

 ● **Take measures to prevent overturning of refrigerator due to earthquake, etc.**

- Overturning of the refrigerator could result in personal injury.

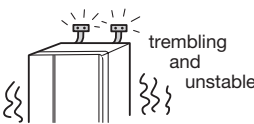

 ● **Do not install the refrigerator in damp places or where water may splash.**

- This may impair electricity insulation causing electric shock or fire.



Wetting Prohibited

Handling the power and power cable

 ● **Avoid usage that may cause the wall outlet or power cord components to work beyond their specified electric current.**

Also do not use power sources that are not a rated AC voltage.

If a power source is shared with other appliances, double or multipoint adapters may heat up beyond normal levels and cause fire.

- Use a wall outlet rated above 10 ampere by itself.





 ● **Do not do anything that may damage the power cord or plug.**

(The power cord or plug should not be cut, modified, touched with hot implements, bent by force, twisted, pulled, have heavy objects placed on it, squeezed by the refrigerator, or be bound or tied up.)

Using a damaged power cord may cause electric shock, short circuits, or fire.

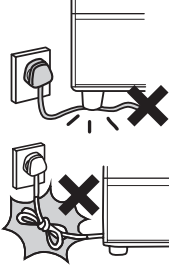
- Please consult with a retailer about the repair of the power cord or plug.



 ● **Connect the power plug firmly to a power outlet with the cord running down.**

- Connection of the power plug with the cord running up could apply stress on the cord and cause electrical short or overheat, which could result in electrical shock or fire.
- Incomplete connection of the power plug could result in electrical shock or fire due to heat.

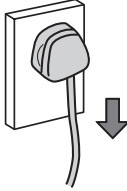

 ● **Clean the dust on the power plug frequently.**

Insulation failure from moisture when dust collects on the power plug may cause fire.

- Unplug the power plug and wipe it with a dry cloth.

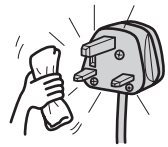

⚠ WARNING

Handling the power and power cable



Wet Hands Prohibited

- **Do not insert or remove the power plug with wet hands.**
 - This may result in electric shock.
- **This appliance is not intended for use by persons (including children) with reduced physical, sensory or mental capabilities, or lack of experience and knowledge, unless they have been given supervision or instruction concerning use of the appliance by a person responsible for their safety. Children should be supervised to ensure that they do not play with the appliance.**



- **Be sure to unplug the power plug before maintaining the refrigerator.**

Continued use may cause electric shock or injury. Pg.66

- Always hold the plug when unplugging it.

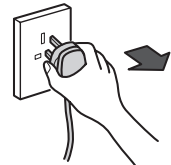

During use



Wetting Prohibited

- **Do not splash water on or inside the refrigerator.**
 - This may impair electrical insulation causing electric shock or fire.

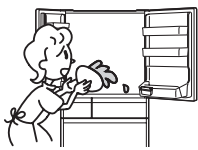

- **Do not put water containers on the refrigerator.**

• Spilled water may impair insulation of electrical components causing faulty electrical currents. This may result in electric shock or fire.



Prohibited

- **Do not put in things that may catch fire.**
 - Benzine, ether, LP gas, thinner, adhesives may ignite an explosion.

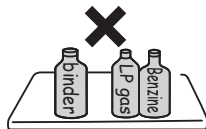

- **Drugs, chemicals, research and experimental substances should not be stored in the refrigerator.**

• Substances that require precise conditions for storage cannot be stored in a domestic refrigerator.



- **Do not use flammable sprays near the refrigerator.**
 - Sparks from points of electrical contact such as door switches may ignite a fire.



- **Do not put things on top of the refrigerator.**

• Opening and closing doors etc. may cause things placed on top of the refrigerator to fall resulting in injury.



- **Do not hang on the doors or step on the various compartments.**
 - Injury may be caused by the refrigerator tipping over or hands getting caught between doors.



- **Do not remove the cover of the interior lamp.**

• When the interior lamp is damaged, please contact the service centre for replacing the lamp to avoid injury.

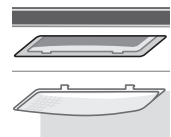

- **Do not put too much force on the door by opening it too much or leaning on the opened door.**

- **Do not add impact to the glass door.**



Contact Prohibited

- **Do not touch the machinery components of the automatic ice maker.**
 - There is a danger of injury when the ice trays are rotating.



- **Children should be supervised to ensure that they do not play with the appliance.**

- **When an infant child may use the Auto Door or Auto Refrigerator Door to make mischief, please stop the Auto Door function.** Pg.50, 51



WARNING



Concerning the refrigerant (Be careful of the following related to the use of flammable gas.)



Prohibited

- Do not scratch or damage the main body of the refrigerator with a sharp object such as screw.

Since the refrigerant used is flammable, any leakage from the pipe inside the wall may cause ignition and explosion.

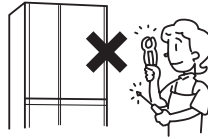

- Do not use mechanical devices or other means to accelerate the defrosting process, other than those recommended by the manufacturer.

- Do not use electrical appliances inside the refrigerator.

- If the refrigerant leaks, sparks on the contact may cause ignition and explosion.



- Do not damage the refrigerant circuit. If you happen to damage the refrigerant pipe, stay away from the refrigerator and avoid using fire and electrical appliances.

Should you damage the refrigerator, open the window to ventilate and contact the authorised service centre.

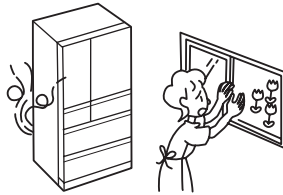

- Allow clearance around the refrigerator and keep ventilation openings when installing it. (→ Pg.48)

Leakage of the refrigerant may accumulate and cause ignition and explosion.

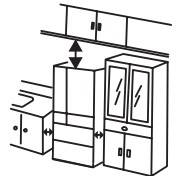

- Please consult your dealer or the Recycle Hotline of the Recycle Centers in the Environmental Protection Administration when discarding the unit.

If the refrigerant leaks, it may cause ignition and explosion.



R600a

- The warning label and name plate including this symbol affixed on compressor and refrigerator should be kept throughout the life of the refrigerator.

In case of emergency



- Stop the refrigerator by unplugging it if it is not running properly or breaks down.

Continuous running may cause electric shock or injury.

- Always hold the plug when unplugging it.

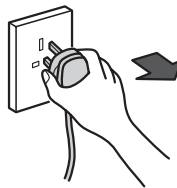

Disassembly prohibited

- Do not disassemble, repair, or modify your refrigerator.

Injury may be caused by ignition of fire or faulty running.

- Please consult with a retailer if any repairs or disassembly are required.



- In the event of gas leak, do not touch the refrigerator and open windows to allow ventilation.

- Sparks from points of electrical contact such as door switches may ignite explosions causing fire or burn injuries.



When discarding the unit



- Before discarding the unit or recycling, remove the door gaskets to avoid the risk of an infant or child being entrapped inside.



CAUTION

When moving the refrigerator



Prohibited

- **Do not move the refrigerator by using its wheels as it may damage the floor.**

- Please lay a protective mat.

- **Never hang the handle with a crane, etc.**
- **Take care not to bang the back / side of the refrigerator.**

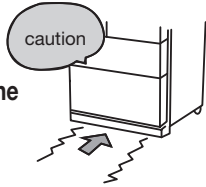

- **Use the carrying handle when carrying it.**

Your hands may slip resulting in injury if you hold the refrigerator at other places than the carrying handles.

- More than 2 persons should carry the refrigerator for safety reasons.
- Carry it with the door facing upward; as shown in the illustration.
- Never hang the handle with a crane.
- Use a tape to fix an electric plug/power cord so that it may not hang down.



During use



Prohibited

- **Do not put bottles in the Door Baskets if they do not sit properly on the bottom of the front section.**

- Forcing in items like large bottles may result in them getting tipped over, causing injury.



- **Do not put the glass bottles in the Freezer Compartment.**

- Bottles may break from the contents freezing and cause injury.

- **When opening or closing a door while the adjacent door is left open, exercise caution lest your hand or a finger should be caught between the opened doors.**

- **Do not close a door while holding a portion other than the handle.**

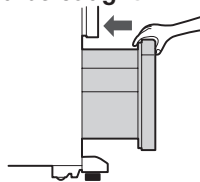

- **Do not put your feet too close when opening the bottom door of the refrigerator.**

- When opening this door you may hit the instep or other parts of your feet resulting in injury.

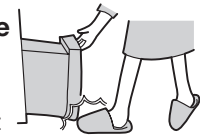

- **Do not put your hands or feet under the base surface of the refrigerator.**

When cleaning, putting your hands under the base surface of the refrigerator may result in injury by cutting them on sheet metal parts.

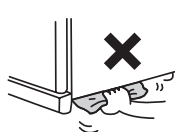

- **Do not give a hard impact to the glass shelf. (The glass shelf may be broken, causing personal injury).**

- **Do not have food items protruding over the front of the shelves.**

- Injury may be caused from items like bottles getting knocked over.

- **Do not open or close the door with force. (Doing so may cause food to drop)**

- **Do not open or close a door while other person is using the refrigerator.**

- **Do not open or close a door of the Refrigerator Compartment while holding the handle of the drawer.**



- **Do not touch the food and containers inside the Freezer Compartment with wet hands.**

- This may cause frost injury. (Especially in the case of metal items)

- **Do not eat food that smells strange or has changed color.**

- Spoiled food may cause serious sickness.

- **Do not press the auto door switch on the auto door compartment with knee, etc.**



- **Avoid placing anything like a bottle near the auto door compartment.**

- **Neither heat the glass surface of the glass shelf nor put a hot item on it.**

- **Be careful not to operate the Auto Door when another person is in front of the refrigerator, which may lead to personal injury unexpectedly caused by the opening door.**



- **To prevent water from dripping on the floor.**

Water due to dew and/or frost may drip on the floor if there is a gap clearance around the door for a long time. Close the door completely without no gap.

- **When opening and closing a door while other door is opened, be careful lest your finger or hand should be caught between the opened doors.**

- **Take care when removing the glass shelf because it is heavy.**

- **When you hear an abnormal sound or find abrasion powder during the opening or closing of a door, stop using the refrigerator and ask us for inspection.**

LEARN NAME & FUNCTION OF EACH PART

Name of each compartment/Food stored

Refrigerator compartment → Pg.52
 About 2°C ~ 6°C

Refrigerating food

The temperature at the door pocket is slightly high.

Vacuum compartment → Pg.54
 About -1°C ~ +1°C

Fresh foods such as meat, fish and seafood
 The vacuum and the platinum catalyst help prevent a reduction in freshness.

Ice compartment
 → Pg.56
 About -20°C ~ -18°C

Ice Storage Space
 Ice made by Automatic Ice Maker
 [Only for R-X730G type]

Small Article Case
 Refrigerants or ice bars → Pg.57

Upper/lower freezer
 → Pg.58
 About -20°C ~ -18°C

**Frozen food/ice-cream/
 dried food**

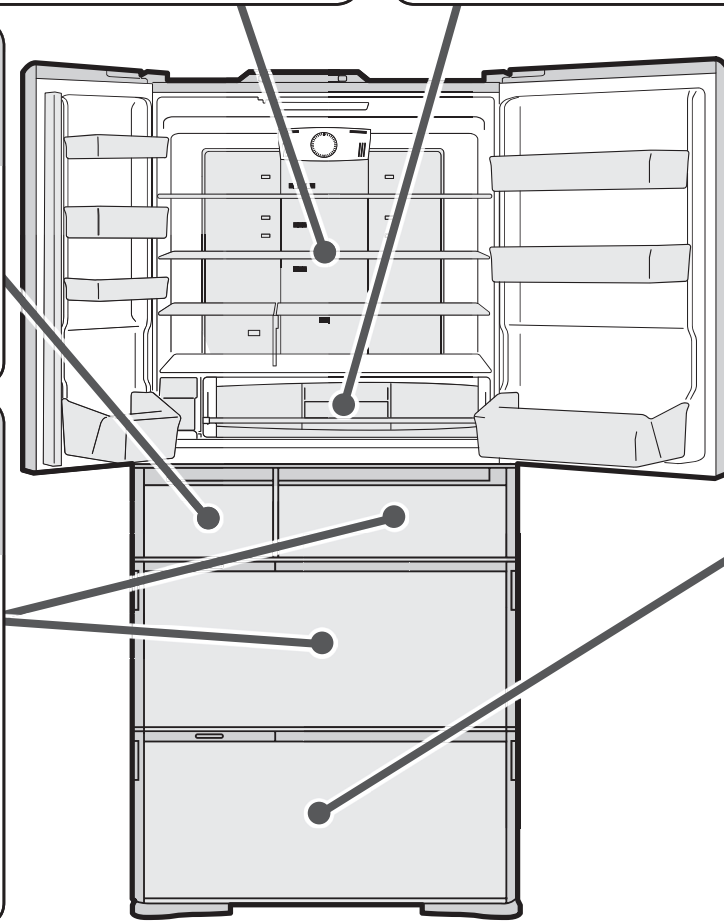

Vegetable compartment
 → Pg.60
 About 4°C ~ 8°C

Vegetable, fruits, drink

Upper space
 Unfinished vegetables, small vegetables, fruits, etc.

Tall Storage Compartment
 Tall vegetables, 2L PET bottle, etc.

The temperature of the Tall Storage Compartment is a little higher.

Lower space
 Leaf vegetables (spinach, Japanese Mustard Spinach etc.), large vegetables (cabbage, lettuce), etc.

※ The above temperatures are standard values under the condition that the refrigerator is stable with no food stored and the doors closed, at ambient temperatures of approximately 32°C, whereas the setting is “■■■” for both refrigerating chamber and freezing chamber.

- Request**
- Store foods in a loosely arranged way.
 - It is recommended to wrap smelling foods.
 - There is a rough guide on the weight of foods that can be stored in the refrigerator. → Pg.79

Functions of the Control Panel

The Control Panel is divided into two sections:

Display Section in the upper part and Operation Section in the lower part.

The Display and Operation Sections are normally unlit. Touch **MENU** to light it up.

The Operation Section is a touch panel. Touch it to toggle the setting.

Notice

- Touch **MENU** to light up the Control Panel and display the current settings. The current settings are also displayed when a door of the Refrigerator Compartment is opened.
- Touch **MENU** again at the end of operation to turn off the light of the Display and Operation Sections.
Even if you do not touch **MENU**, the display and Operation Sections go out after approx. 40 seconds for energy savings, except for the indicators of the "Energy Saving" mode, "Freezer", "Quick", "Off", "Water", "Off" (Non-vacuum), ["eco" Operation], and [Door Open & Close].
- The Display and Operation Sections are lighted up when a door of the Refrigerator Compartment is opened. They go out approx. 15 seconds after the door is closed.

Providing information

| | |
|------------------|---|
| eco | It will turn on while it is working in "eco" mode. → Pg.62 |
| Key | It will turn on while the Control Panel is locked. → Pg.63 Blink indicating any trouble. → Pg.73 |
| Auto Door | Is lit when the Auto Door function is turned ON. → Pg.50 |
| Water | It will turn on when water in the water supply container is getting low. → Pg.57 |
| Door | Is lit when a door is frequently opened or closed. → Pg.62 |

※All the indicator lamps are lit for the sake of explanation.

Setting Energy Saving mode

Energy-saving by reducing cooling power of each compartment.

"Save" → Pg.62

Adjusting temperature settings

Normally, use the "■■■" setting.

Refrigerator Compartment → Pg.52

Freezer Compartment → Pg.58

Setting an ice-making

"Quick" → Pg.57

"On" → Pg.56

"Off" → Pg.57

Setting a cooling mode

"Delicious Frz" → Pg.59

"Freezer" → Pg.59

"Veg" → Pg.61

Setting the Vacuum Compartment

+1°C → Pg.55

-1°C → Pg.55

"Off" → Pg.55 (Non-vacuum)

Notice

- Response of the touch panel may change depending on the surrounding temperature, humidity, physical condition of the user or operation status of the adjoining electric product.
- Release a finger and touch the panel again if the panel does not respond after touching it. False detection may occur (it may be kept pressed) if the time interval between key touches is too short. Response of the touch panel does not improve even if you touch it strongly.
- The panel may not respond if it is wet or dirty. After removing dirt with a wet cloth, wipe off the water with a dry cloth.
- While a door of the Refrigerator Compartment is left open or the Display Section is blinking, the Operation Section remains inactive even if you touch a button.

BEFORE USE

Preparation before use

1

Please arrange it as shown below

- The floor should be sturdy and flat.
Lay a board with 1cm thickness on the floor if the refrigerator is installed on the carpet, tatami mat, flooring or PVC sheet flooring which may be hollow or discolor.
- Place the refrigerator away from direct sunlight and heat.
- Do not place it in damp areas, and ensure good air ventilation.
This will reduce adverse effects to refrigerating power and keep electricity cost down. This will also prevent the refrigerator from discoloring and rusting.
- The place should be separated from other equipments.
To prevent disturbance (noise / scattered image) to TV and others attributable to the refrigerator.
- ※ To cool efficiently, allow enough space around the refrigerator for radiating heat.
- ※ The actual size of the center part of the side of the refrigerator's main body is slightly larger than the nominal size. Therefore, please allow enough space around when installing the refrigerator.
- ※ The back of the refrigerator can be placed very close to the wall.
If you care about vibrating sound or dew condensation on the rear or discoloration of or dirt on a wall due to high humidity, install the refrigerator so as to form a gap of 2 cm or more.

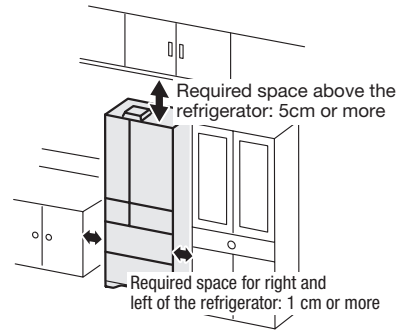

2

Fix the refrigerator

The adjustable mounts, which are located in the front bottom corners of the refrigerator, can be adjusted by turning them to level the refrigerator. (Make sure to use a supplied tool and 2 cushions)

- 1** To remove leg cover, hold both ends of it and pull it towards you by applying some force.

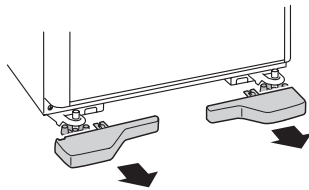

- 2** Place pads under the adjustable mounts.
Place pads under the adjustable mounts evenly so that they can be leveled.

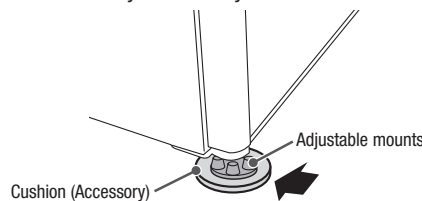

- 3** Lower both adjustable mounts (left and right) by turning them to secure the refrigerator.
Clamp the supplied tool adjusting to the shape of the adjustable mounts.

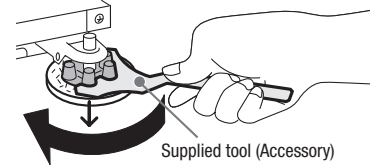

- Always wipe the adjustable mounts and floor clean before placing pads. Adherents may scratch the floor if they remain.
- Be careful not to scratch the floor with the supplied tool when turning the adjustable mount.
- Excessively turning an adjustable mount may cause it to detach.

3

Adjusting the refrigerator adjustable mount to keep it level

- Installing the refrigerator on an unlevel floor or sinking of its leg(s) due to a floor which is not strong enough to support the weight of food may cause a difference in level between the right and left doors.
This does not affect the refrigerator function. Adjust the refrigerator adjustable mount to keep it level according to the procedure listed below if you want to correct it.
Correcting any left/right lean and lifting slightly the front side of the refrigerator until the door can close easily and completely.

- 1** With the supplied tool, turn an adjustable mount on the side so that the refrigerator is lower to make the Refrigerator Compartment door level.

The height of the door can be adjusted 1mm every one turn of the adjustable mount.

- The left side door is lower.

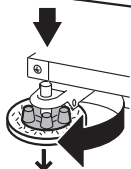
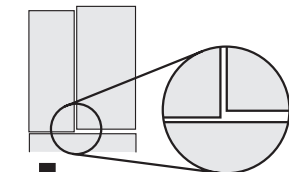

Turn the left Adjustable mount to lower the left side door.

- The right side door is lower.

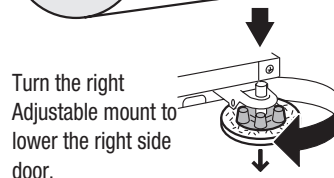
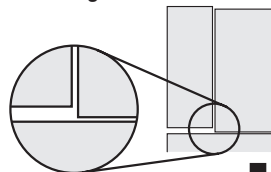

Turn the right Adjustable mount to lower the right side door.

- 2** Insert the fork of the leg cover into the mounting holes to attach the cover.

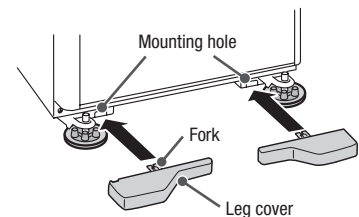

Depending on the material or strength of a floor on which the refrigerator is installed or the weight of food put in it, a door may sag in several days (about five days) after the installation. If this happens, adjust the parallelism between the doors again.

Notice

- When you release your hand from a refrigerator door with the door open, the door may move, but this is normal.

4

Plug the power cord.

It is not a problem to plug in the power cord soon after installing the refrigerator.

Use a wall outlet exclusively when connecting the power cord. (Alternating current 220 - 240V, rated 10A or more)

- Check that the power plug or the cord is not wedged between the back of the refrigerator and the wall in order to prevent the cord from getting hot.

Cooling inside the refrigerator starts.

- It may take more than 4 hours to cool well the inside of the refrigerator, depending on conditions such as the ambient temperature or storage state of foods. It may take 24 hours or more in summer, etc.

Do not put ice cream, uncooled foods or perishable foods in it until the inside of the refrigerator is cooled well.

- Perform "Ice Maker Cleaning" when using the automatic ice making function first. (→ Pg.68)
- A series of ice making operation will start automatically after the inside of the refrigerator is cooled well. (When using for the first time, it may take 24 hours and more to make ice.)

Notice

- If you wish to install the refrigerator in a hot spring area exposed to sulfide gas, you may need to apply anti-rust treatment to the piping. Contact your dealer in advance. Failure caused by sulfide gas will not be covered under guarantee.
- After inserting the power plug into a wall outlet, you will hear noise from the refrigerator, which is preparing for operation. You may also hear a louder noise from the compressor or fan until the inside is cooled down enough.
- It may give off a smell of plastics in the beginning when you start to use. Keep the room well-ventilated. Such smell will disappear gradually.
- Do not peel off the seal on the back or plastics at the lower part of the side.
- When a magnet or suction cup is attached on the side of the body or the surface of a door, it may leave a mark.
- When you attach a paper sheet on the door surface in a high ambient temperature, dew may form on the door surface, or the paper may absorb moisture.

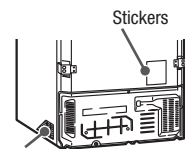

Plastic parts - Left/Right

Transporting your refrigerator (transport for moving)

1 Take out foods or ice.

2 Empty the water from the water supply container/ice tray.

3 Pull off the power plug.
No problem just before moving.

4 Remove the leg covers, and raise the adjustable mounts.

5 Use a tape to secure the door/power cord.

6 Place a sheet or cloth for protection when moving / transporting it.
To prevent damage to the floor material or water from spilling out.

7 Place a sheet or cloth for protection first, and then lay it back to drain water.

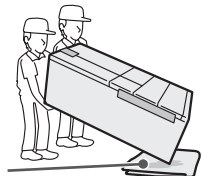

Such as old cloth

8 Make sure to hold the handles when carrying it with 2 persons or more.

Do not lay it down horizontally for transportation (which may cause failure of the refrigerator).

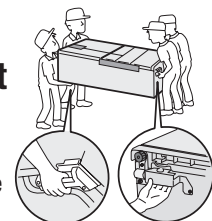

9 See "Preparation before use" for installing the refrigerator in a new location. (→ Pg.48)

Auto Door

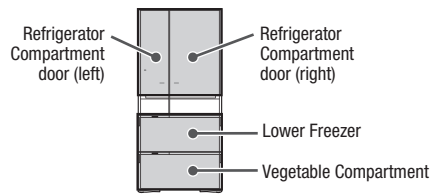

- Auto Refrigerator Door** You can open the door easily by touching the door lightly with your fingers thanks to the Auto Door function. (Only R-X730G type, R-X670G type)
- Auto Drawer** Auto Drawer function helps you to pull out the case easily even if it is heavy with plentiful foods in.

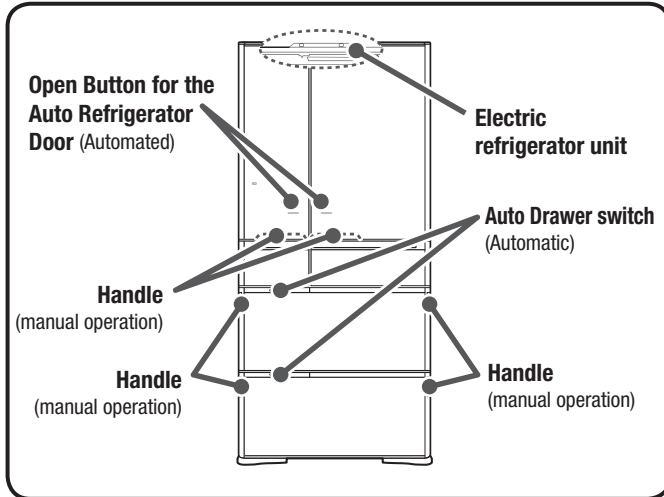

Caution

- When an infant child may use the Auto Door to make mischief, please stop the Auto Door function.
- Do not operate the Auto Refrigerator Door Switch when another person is in front of the refrigerator (which may lead to personal injury unexpectedly by the opening door).
- Do not bring your foot too near the refrigerator when you press the Auto Drawer switch of the vegetable compartment. (You may knock your foot against the door and may cause injury)
- Do not put any item on the refrigerator.
- Do not hold any portion of the door other than the handle. (This can cause pinching of fingers, which could result in injury.)
- Operate the auto door switch with your hand.
- Be sure to unplug the power plug before cleaning the Auto Door.

Setting the Auto Door

You can enable or disable the Auto Door function. The function is enabled when shipped from the factory.

- 1** Touch **MENU** button on the Control Panel to turn on the indicator lamp.
 All indicator lamps turn on, and then the current settings are displayed.
- 2** Press and hold **Freezer** for three seconds or more until the preset sound (long beep) is heard to turn on the "Auto Door" indicator lamp.

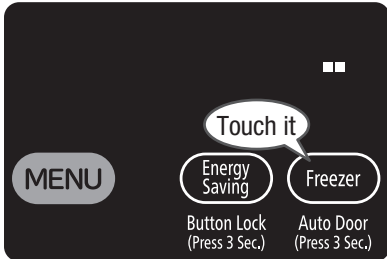

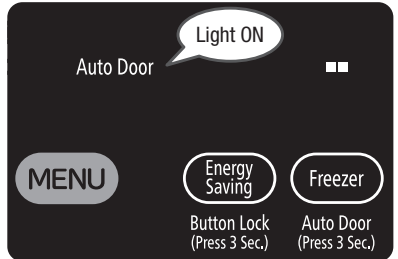

(Factory setting / At the time of setting)
- 3** Touch **MENU** on the Control Panel to turn on the indicator lamp, press and hold **Freezer** for 3 seconds or more until the preset sound (2 beeps) is heard to turn off the "Auto Door" indicator lamp.

Notice

- When the Auto Door function is turned "off", open the door with the handle.
- The Auto Door function cannot be disabled for either Auto Refrigerator Door or Auto Drawer only.

Using the Auto Refrigerator Door



When touching the Open Button for the Auto Refrigerator Door, the operation sound is heard, and then it will open automatically.

Request

When closing it, use the handle with your hand to do so.
The door does not close automatically.

Notice

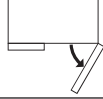
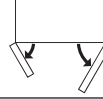
- The Auto Refrigerator Door does not open when either the “Ice Compartment” or the “Upper Freezer” is opened to prevent hands from being caught.
- The Auto Refrigerator Door is a function to reduce load incurred at the beginning of the opening of the door of the Refrigerator Compartment. Opening angle of the door may vary or the door may slightly go back, depending on installation condition of the refrigerator or how beverages or foods are stored in the door pocket, but this is not malfunction.
- After touching the Open Button for the Auto Refrigerator Door, the operation sound may be heard when opening the door, but this is not malfunction.
- If the Open Button for the Auto Refrigerator Door is wet or dirty, it may not respond. Use a wet cloth to wipe off dirt, and then wipe it with a dry cloth.
- If you touch the Open Button of the Auto Refrigerator Door and its neighboring part at the same time, or you touch it for about one second or more, the Auto Refrigerator Door may not be opened automatically.

| | | |
|--|--|---|
| How to open the Auto Door | Opening one door on either side Top view of the refrigerator  | Open both doors at a time Top view of the refrigerator  |
| How to operate | Touch the Open Button of the door to be opened * Operate with a finger.  | Slide your finger from one edge of the Open Button to the other. (Doors will open in turn from the side you touch.)  |
| Operation sound of the Auto Refrigerator Door | 1 beep | Long beep |

Using the Auto Drawer

Press the Auto Drawer to automatically open the drawer.

When you close it, push the handle on the right/left to close.
The door does not close automatically.

Notice

- This function is to reduce an initial load when pulling out the Auto Drawer. The Auto Drawer can be pulled out by approx. 15 cm or more. The length may vary depending on installation conditions of the refrigerator, or the door may go back a little after the door is opened automatically, but it is normal.
- “Lower freezer” and “vegetable compartment” cannot be electrically opened at the same time.
- When one of the “lower freezer” and “vegetable compartment” is open, the Auto Drawer function does not work.
- A sound is heard when you press the Auto Drawer switch. This is not abnormal.
- Wipe off spilled liquid and others on the Auto Drawer switch immediately.
Or Auto Drawer switch may fail to work, causing the door open disorderly.

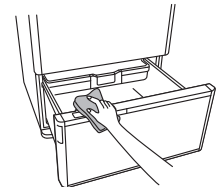
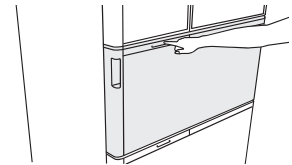

REFRIGERATOR COMPARTMENT

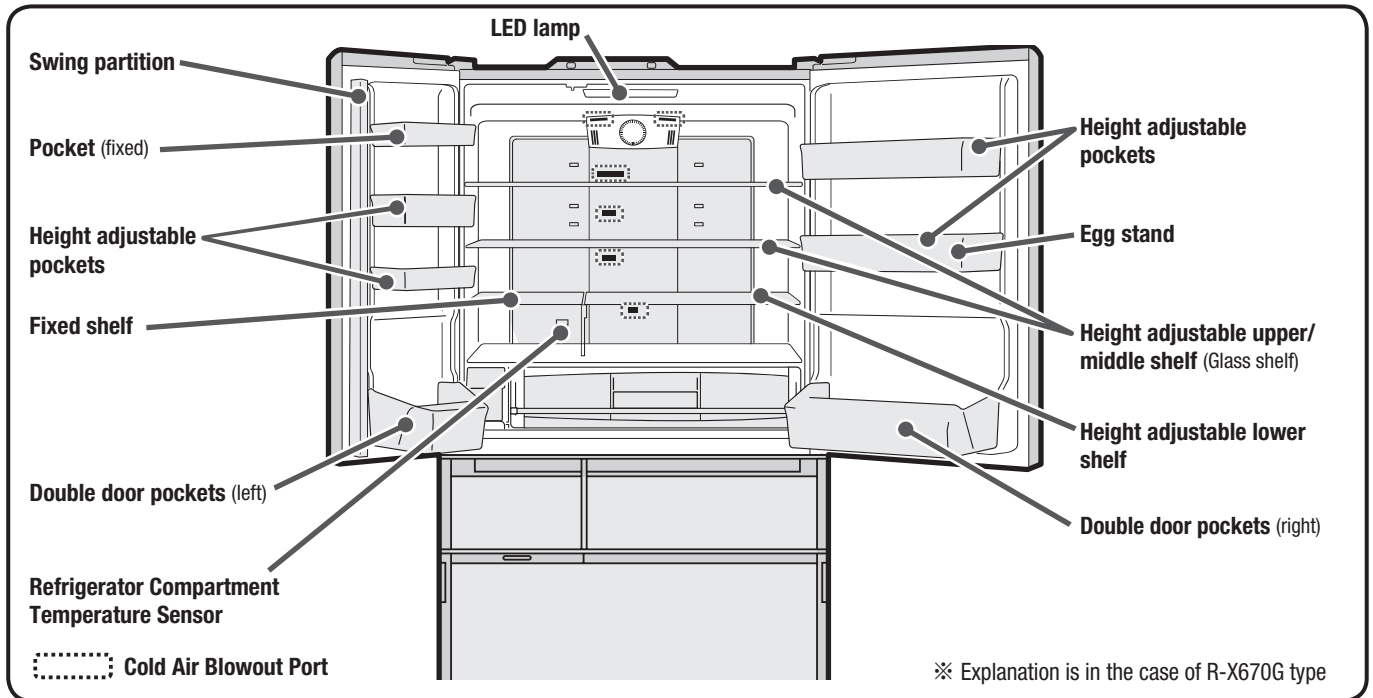
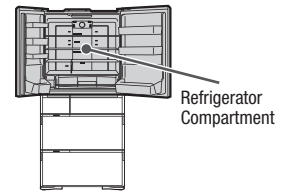

Request

- High moisture foods/canned beverages may be frozen or burst if they are placed around the Cold Air Blowout Port. Place them near the front side of a shelf or in a pocket.
- Store hot foods on the Height adjustable shelf. If it is placed near the temperature sensor, the temperature of the Refrigerator Compartment may get too lower or dew may adhere to the panel at the back of the Refrigerator Compartment.

Caution

- Storing a bag containing bread in the Refrigerator Compartment may cause dew condensation in the bag, which moistens the bread.
- Do not put too much force on the door by opening it too much or leaning on the opened door, which may cause damage to the door.

Adjusting temperature in a refrigerator compartment

1

Touch **MENU** button on the Control Panel to turn on the indicator lamp.

All indicator lamps turn on, and then the current settings are displayed.

2

Touch **Fridge** button to set the temperature as you like.

Each time you touch the button, the corresponding indicator lamp changes in the order shown in the figure on the right.

The temperature is set to "■■■" before shipping.

Notice

- Select "■■■" in ordinary usage. The temperature may change depending on the operation states.
- If you adjust the temperature more finely. → Pg.65
- The temperature of the Vacuum Compartment also changes if selecting "■■■■" or "■".
- Temperature of the door pocket is slightly higher than the one in the figure on the right.
- If cooling is not enough during summer, select "■■■■".
- When you use "■■■■" for a long time during winter, food may be frozen. If the inside is too cool, use "■■■" or "■".

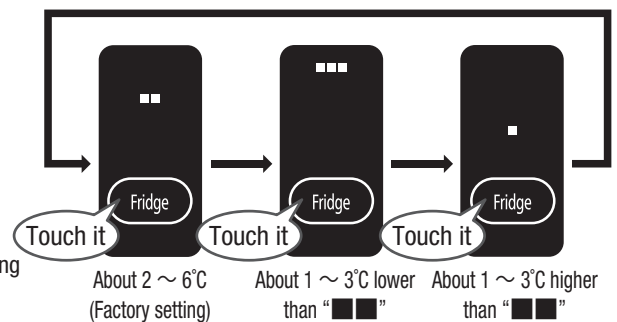

※ The above temperatures are standard values under the condition that the refrigerator is stable with no food stored and the doors closed, at ambient temperatures of approximately 32°C, whereas the setting is "■■■" for both refrigerating chamber and freezing chamber.

Adjust the height of a pocket/shelf

You can adjust the position of the pocket and the shelf depending on size of foods or beverages.
For how to remove/attach, see [→ Pg.70](#) .

■ Height adjustable pockets

Height adjustable upper/middle shelves

You can adjust the position of them depending on the height of foods or beverage.

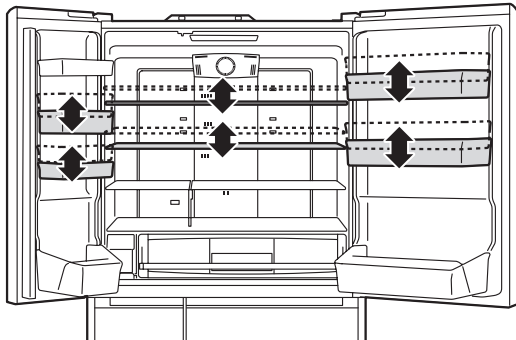

■ Height adjustable lower shelf

You can adjust them in three-stages.

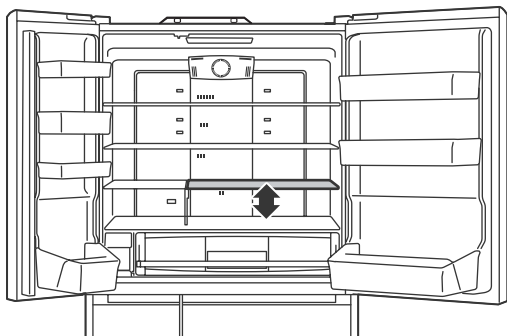

CAUTION

■ Handling the glass shelves

- Avoid a high impact on the glass shelf.
(A broken glass may cause injury)
- Be careful to attach the glass shelves because they are heavy.

■ When opening a door

- Do not hold the swing partition to open the door.
(It may make it impossible to open the door.)

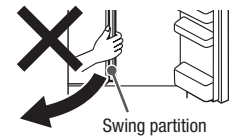

■ When closing a door

- Do not close the door with the swing partition erected.
(It may make it impossible to close the door completely.)

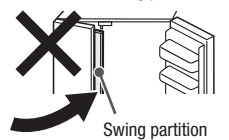

R-X730G type, R-G620G type

- State in shipping
- Storage of pans, etc.
- Storage of milk carton, etc.

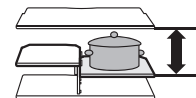
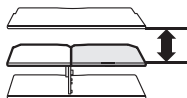

Mount the shelf board at the middle level.

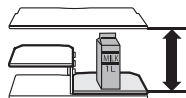

Mount the shelf board at the lower level.

R-X670G type, R-G670G type

- State in shipping
- Storage of pans, etc.
- Storage of milk carton, etc.

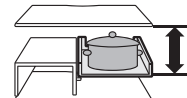
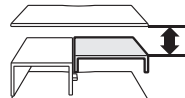

Turn the upside of the shelf board down and mount it at the upper level.

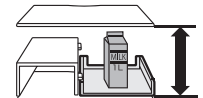

Turn the upside of the shelf board down and mount it at the lower level.

VACUUM COMPARTMENT

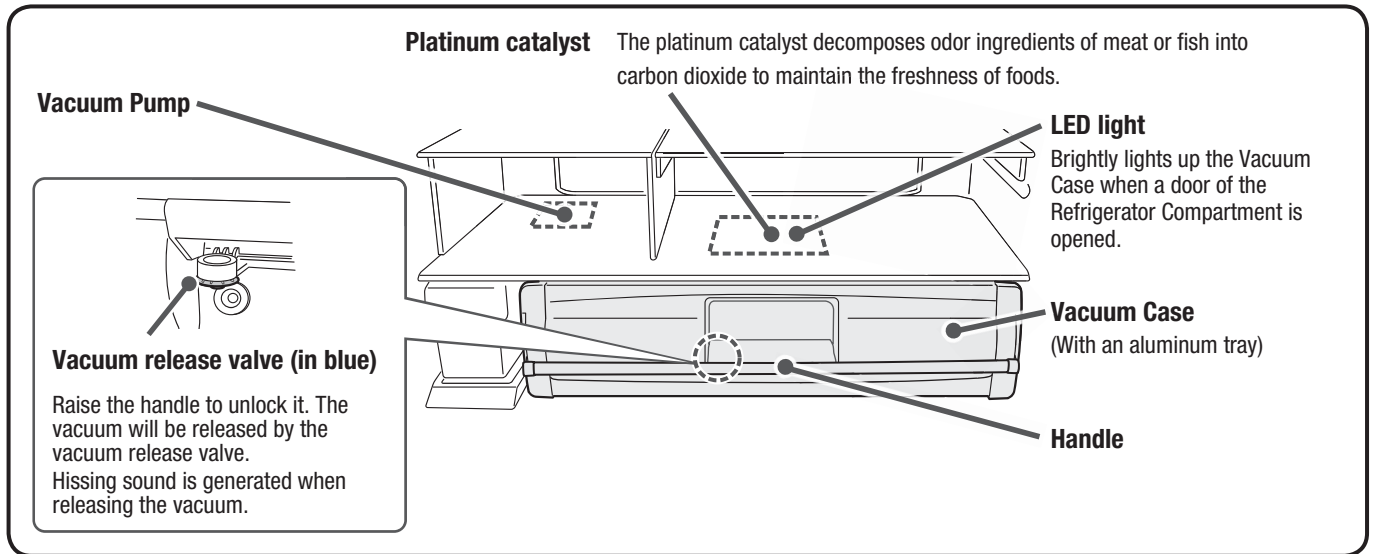
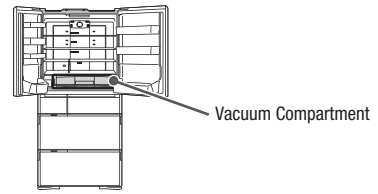

When opening/closing the door of the Vacuum Case

When opening the door

1

Pull up the handle to unlock.

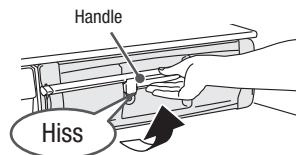

Notice

- It takes about three to four minutes for the Vacuum Case to be vacuumed after the vacuum pump starts to operate. The hissing sound may not be heard when the Vacuum Case is opened within four minutes.
- If you pull out the Vacuum Case without opening the door on the left/right, it may cause damage to parts.

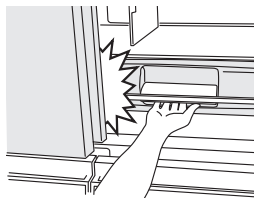

2

Pull out the Vacuum Case.

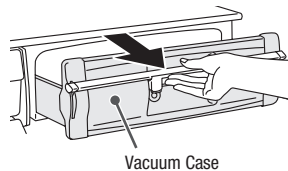

Notice

- The hissing sound indicates that vacuum is being released. Thus, the Vacuum Case cannot be drawn out while the sound is heard. Draw it out after the sound is no longer heard.

Request

- The platinum catalyst needs no replacement. Do not remove it.

When closing the door

1

Push the Vacuum Case back to the end.

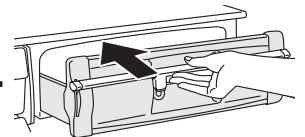

Request

- Do not overfill the Vacuum Compartment with food or containers. Doing so may make it difficult to draw out the Vacuum Case.
- If you close the Refrigerator Compartment door with the Vacuum Case opened, parts or foods may be damaged.

2

Press down the handle to lock.

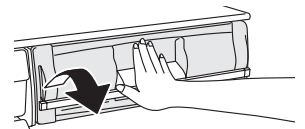

Notice

- The Vacuum Case is not put in the vacuum state unless the handle is pushed down securely.
- Closing the door of the Refrigerator Compartment without locking the handle may damage parts or food or form a clearance between the doors, which reduces cooling performance.
- The vacuum pump is activated when the door of the Refrigerator Compartment is closed, with the Vacuum Case closed and the handle locked.
- Sound is heard when the vacuum pump starts. This is a normal operation.

Change the settings of the Vacuum Compartment

1 Touch **MENU** button on the Control Panel to turn on the indicator lamp.

All indicator lamps turn on, and then the current settings are displayed.

2 Touch **Vacuum** button to change the settings as you like.

The display switches in sequence as shown below every time the button is touched.

The temperature is set to “-1°C (Subzero)” before shipping.

Caution

- The “Off” indicator lamp continues to be lit during the “Off” operation. The display will be turned off after about 40 seconds for energy saving, but the function that is set once will remain effective.

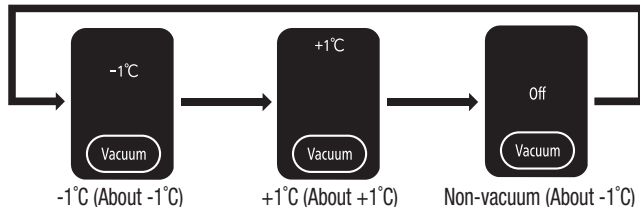

-1°C (About -1°C)
(Factory setting)

+1°C (About +1°C)

Non-vacuum (About -1°C)

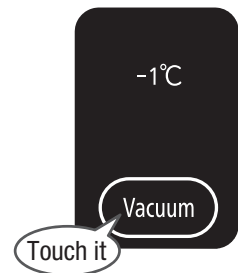

※The above values are obtained with an ambient temperature of 32°C, the temperature in the Vacuum compartment in a stable state with no food stored and no door opened.

Settings and food stored

| | |
|-------------------------------------|------------|
| -1°C (Subzero) (About -1°C) | Vacuum |
| +1°C (Chiller) (About +1°C) | Vacuum |
| Off (Vacuum off) (About -1°C) | Vacuum OFF |

The following foods should be stored at “-1°C (Subzero)” setting.

- Meat, processed meat
- Fish, seafood, boiled fish paste



This setting is also suited for thawing. Foods high in water content may freeze.

The following foods should be stored at “+1°C (Chiller)” setting.

- Dairy products
- Food which form air bubbles inside if frozen



Cheese etc.



Tofu, konnyaku, deep-fried tofu, string konnyaku, boiled eggs etc.

- Precut vegetables and fruits
- Others



Precut vegetables or fruits



Coffee beans, tea leaves etc.

Food and container for which care needs to be taken during storage

- Food contained in a sealed bag
A bag containing food may inflate and crush other food.



Vienna sausage, sliced cheese etc.

Caution

- Plastic airtight container
The lid of the container may become loose or may not stay in place during storage. Be careful when you take out the container.



Caution

Food which are not suitable for storage

- Vegetable sensitive to low temperature
The surface of the vegetable may deteriorate due to low temperature. Store it in the Vegetable Compartment.

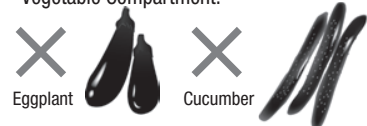

Okra, asparagus, ginger, and green pepper

Notice

- The vacuum effect will not be changed even if foods are wrapped. If you are concerned about the transfer of smell, be sure to wrap the food.

Caution

- Foods high in water content may freeze if ambient temperature is low.
- When putting together food materials that should be stored at subzero and chiller temperatures, set the temperature to “+1°C” to prevent freezing.
- The temperatures of the Vacuum Compartments also change if the temperature of Refrigerator/Freezer Compartment is set to “■■■■” or “■”.

Request

- Dew and/or frost may be formed in the sealed Vacuum Compartment due to moisture contained in food or in the air. Soak a soft cloth in lukewarm water and wipe off the dew and/or frost with the cloth. (Attached dew, frost or ice does not reduce performance.)
- If you want to avoid dew, frost or ice, stored food should be wrapped with plastic wrap.
- Wipe water or soup spilled in the compartment soon, if any.

Dew, frost or ice

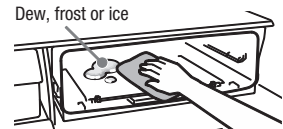

ICE COMPARTMENT (AUTOMATIC ICE MAKER)

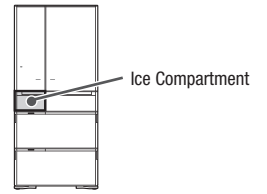

Water Supply Container
(Approx. 1.0 L)

Control Panel

Ice Making buttons

Ice Case

R-X730G type

R-X670G type
R-G670G type
R-G620G type

Ice Storage Space

Container-full line

Small Article Case

Ice scoop

Ice Tray

How to make Ice

Perform "Ice Maker Cleaning" when making ice for the first time or for the first time in a week or more. → Pg.68

1 Touch **MENU** button on the Control Panel to turn on the indicator lamp.

All indicator lamps turn on, and then the current settings are displayed.

2 Touch **Ice Maker** button to turn on "On" indicator lamp.

The "On" mode is set to "On" (light on) before shipping.

Touch it (Cleaning Press 5 Sec.)

3 Take off the Water Supply Container.

When the "Water" indicator lamp is lit or the water level reaches to the "Add water line", replenish water.

Add water line

4 Open the lid and add water.

Water level can not exceed "Container-full line".

※ Do not pour water into it beyond the full water line.

Lid

Container-full line

5 Replace the Water Supply Container.

Push it straight beyond the "Container set position" line completely.

Water will not be supplied until the water supply container is pushed to the end.

※ Water may spill out if the water supply container is inclined. Wipe off spilled water immediately.

Container set position

6 Ice-Making starts automatically.

- Ice cubes are stored in the Ice Case.
- 12 pieces of ice cubes are made by one ice-making operation.
- When ice cubes reach the Container-full line, the automatic ice-making function is suspended. The function automatically resumes when ice gets low.
- When the Ice Case contains no ice cube, you may hear a large sound when ice cubes fall from the Ice Tray.

Request

- **WARNING:** fill with potable water only.
- Water for ice making is according to your drinking standard. Quality of tap water may vary in different countries. Please check and verify with your local authority.
- Change water and clean the container at least once a week for hygiene purposes. → Pg.69
- If the ice made of mineral water containing a lot of mineral ingredients is put into water, white powder may come out, however this is due to those mineral ingredients and harmless.
- Furthermore, these types of water are easily contaminated with bacteria. Please wash the container usually once 3 days.

Mineral water
(Hardness: 100mg/L or less)

Filtered water or
boiled water

Well water
(Required to satisfy the appropriate
water quality standard)

- Do not use the following ones because they may cause malfunction, deformation or sticking ice.

Juice drink

Sports drink

Carbonated drink

Tea

Notice

It may take longer time to make ice in the following cases:

- It is used for the first time (it may take 24 hours or more).
- It is set to the "Energy Saving" mode.
- The door is opened/closed frequently.
- Large volume of foods is stored in the refrigerator at a time.
- In case of power outage.
- With the low ambient temperature in winter, etc.
- After the ice tray is cleaned.
- When the door of the Freezer Compartment / Ice Compartment is not closed completely.
- When the temperature of the Freezer Compartment is set to "■".
- When something hot is stored in the Small Article Case (for only R-X730G type).

Quick Ice Making

1 Touch **MENU** button on the Control Panel to turn on the indicator lamp.

All indicator lamps turn on, and then the current settings are displayed.

2 Touch **Ice Maker** button to turn on “Quick” indicator lamp.

Ice cubes are made in a shorter time than that of “On” operation.

12 ice cubes are made by one ice-making operation.

“Quick” operation ends automatically in about 7 hours, and it is changed to “On” mode.

Notice

- “Quick” indicator continues to be lit during the “Quick” operation. The [“eco” operation indicator lamp] is not turned on.

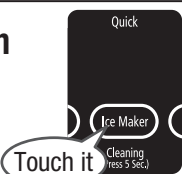

Stop Ice Making

1 Touch **MENU** button on the Control Panel to turn on the indicator lamp.

All indicator lamps turn on, and then the current settings are displayed.

2 Touch **Ice Maker** button to turn on “Off” indicator lamp.

Stop the Automatic Ice Maker and make no ice.

※ If you set to “Off” for 1 week or more, maintain the Automatic Ice Maker. → Pg.68, 69

Notice

- “Off” indicator continues to be lit during the “Off” operation.



Stored ice amount and ice-making time

| Model | | R-X730G type, R-X670G type R-G670G type, R-G620G type |
|---|------------------|--|
| Stored ice amount | Normal operation | About 90 pcs |
| | Ice is leveled | About 150 pcs |
| Time for one-time ice making (12 cubes) | Normal “On” | About 110 minutes ~ 140 minutes |
| | “Quick” | About 80 minutes |

※ The above values are obtained with an ambient temperature of 30°C, the temperature in each compartment set to “■ ■” and no door opened/closed.

Notice

- Limit line of stored ice amount represents the guide line of stored ice amount when the Automatic Ice Maker makes ice with ice leveled. If the ice is stored partially, the detecting lever may contact the ice early. As a result, the Automatic Ice Maker may stop making ice before the amount of stored ice is enough.

Request

- Gently open and close the door of the Ice Compartment, otherwise ice may fall out of the ice case onto the lower freezer.

Small Article Case (for R-X730G type only)

| | |
|--------------|--------------------------|
| Stored foods | Refrigerants or ice bars |
|--------------|--------------------------|

Notice

- When putting something hot, ice in the Ice Storage Space may melt or ice-making may take a long time.
- Ice cream may be soft due to indirect cooling.
- Be sure to close the lid. Do not put an object which is too large to close the lid.

Water Supply indicator

“Water” indicator lamp comes on when water in the water supply container is getting low. Replenish the container with water.

While the “Water” indicator lamp is on, the Ice Making function doesn’t work even if the “On” and “Quick” is set.

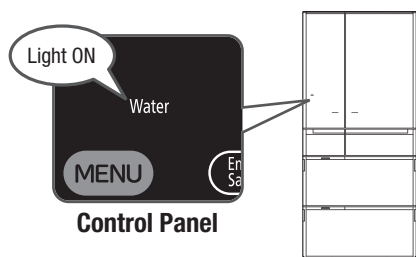

Notice

- “Water” indicator lamp turns off once (for up to 3 hours) when the left door of the Refrigerator Compartment is opened and closed while the indicator lamp is on, and it turns on again if no water is added to replenish the container.
- “Water” indicator lamp remains off when “Off” is selected for automatic ice making.

Caution

- “Water” may come on regardless of water level if the water supply container is not placed properly. Push in the container straight and completely if the indicator lamp comes on.

When the “On” indicator lamp blinks

The ice tray may come into contact with foods within the Ice Case.

Empty the Ice Case once, and then start the “Ice Maker Cleaning”. → Pg.68

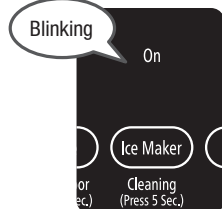

Request

- Do not put frozen food other than the ice cubes made by the Automatic Ice Maker in Ice Storage Space. (Doing so may prevent ice-making, damage parts or bring a part of the ice maker into contact with food, which may prevent the opening of the door.)

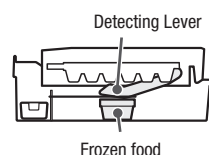

Is any frozen food stored in the inner part of the Ice case?

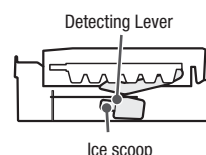

Is the Ice scoop placed in a given place?

FREEZER COMPARTMENT

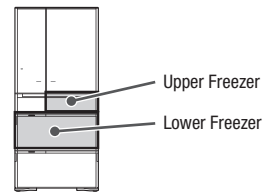

Using the Upper Freezer

Use it to keep daily foods or partially used food.

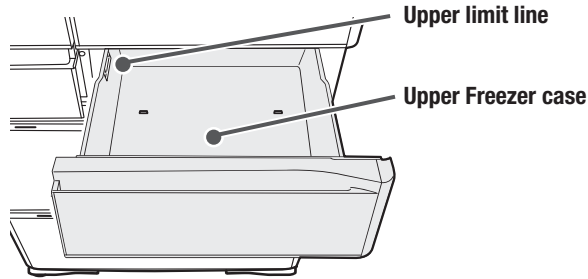

Caution ● Don't put foods beyond the upper limit line.

Stored foods

| | |
|---------------------------|--|
| Upper Freezer case | Freezing bag, airtight container, etc. Space for small-item and frozen food, etc. |
|---------------------------|--|

Caution on how to store foods

Store foods properly depending on the height of them.

Otherwise the door may not be closed completely, which leads to inefficient cooling action, and also may cause damage to the food or cases. Keep the food off from bottom of the upper slimline case and/or the slide case.

Guideline for height

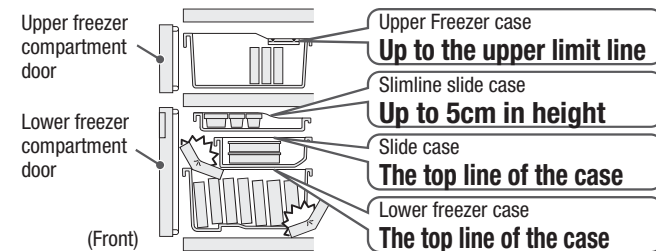

- Do not store any 500ml PET bottle in the Slimline slide case. It may not be taken out because it expands when it is frozen.
- Do not use with the slimline slide case and/or slide case removed. Food may drop to the inner part of the case, and as a result, the door may not close completely.

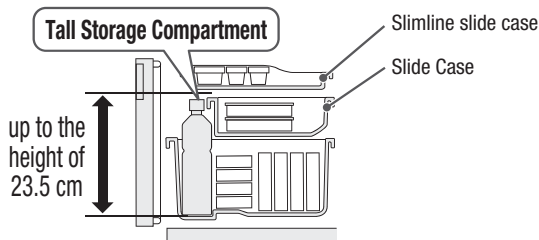

- When storing tall food in the tall storage Compartment, make sure that it does not contact with the Slimline Slide Case and/or the Slide Case.
- Store only food which can be frozen such as PET bottle which can be stored in freezer.

Using the Lower Freezer

3-layer freezer case provides you with large storage space compartment and convenient reach of your freeze food items.

It is suitable for storing the food preserved for a long time and the food that melt easily such as ice cream.

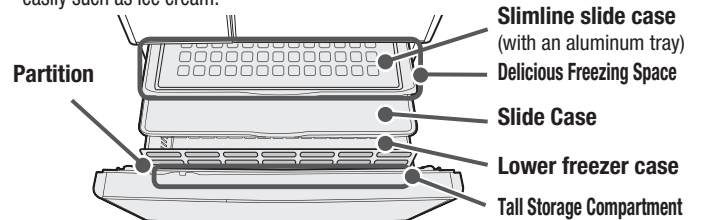

Caution ● Do not remove the Slimline slide case and the partition.

Stored foods

| | |
|----------------------------|---|
| Slimline slide case | Small-item and frozen food, etc. Delicious Freezing Space When you want to freeze meat, fish or rice quickly |
| Slide Case | Freezing bag and airtight container etc. |
| Lower freezer case | Frozen food and bread, ice cream etc. Tall Storage Compartment PET bottle for freezing, etc. |

Adjust the temperature of the freezer compartment

1

Touch **MENU** button on the Control Panel to turn on the indicator lamp.

All indicator lamps turn on, and then the current settings are displayed.

2

Touch **Freezer** button to set the temperature as you like.

Each time you touch the button, the corresponding indicator lamp changes in the figure on the right: The temperature is set to "■■■" before shipping.

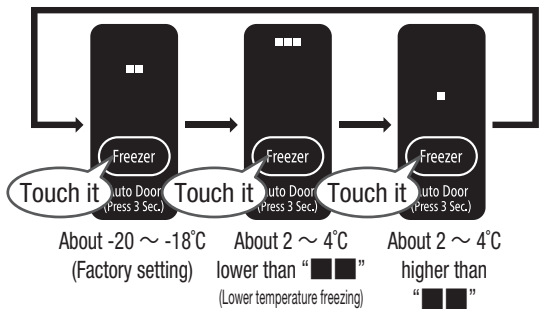

※The above temperatures are provided as a guide when the inside temperatures are stabilized at the ambient temperature of 32°C under the conditions that: The temperatures of the Refrigerator and Freezer Compartments are set to "■■■" and the doors are closed without storing food.

Notice

- Select "■■■" in ordinary usage. The temperature may change depending on the operation states.
- If you adjust the temperature more finely. → Pg.65
- The "■■■■" setting of the Freezer Compartment (lower temperature freezing) consumes more energy than the "■■■" setting by approximately 20%.
- If operating the refrigerator for a long time with the Freezer Compartment "■■■■" selected, ice cream etc. may become hard or it may take a longer time to thaw food.
- If the temperature of the Freezer Compartment is changed, the temperature of the Ice Compartment changes.

Using the Delicious Freezing

Just by placing a food item in the Delicious Freezing Space, the sensor detects it and automatically toggles to the cooling operation. It can freeze food more quickly, boosted by the effect of the aluminum tray.

Wrap a food item with food plastic film or put it in a freezing bag and then place it on the aluminum tray. Dividing a food item into small lumps and flattening them allows the center of each lump to be frozen quickly and facilitates the taking-out of the frozen food.

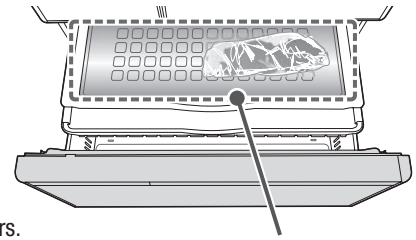

Delicious Freezing Space

Notice

- Put food items on the aluminum tray such that they are in a close contact with it, instead of placing them on the top of each other.
- Hot rice etc. can be frozen while it is still hot. Placing a hot food in the refrigerator may burn your fingers. It is recommended that you should cool it down to a temperature that allows you to hold it with your hand.

Setting the Delicious Freezing

You can enable or disable the Delicious Freezing function. The function is enabled when shipped from the factory.

1 Touch **MENU** button on the Control Panel to turn on the indicator lamp.

All indicator lamps turn on, and then the current settings are displayed.

2 Press and hold **Powerful** for three seconds or more until the preset sound (long beep) is heard to turn on the “Delicious Frz” indicator lamp.

Notice

- Although the indicator goes off about 40 seconds for energy savings, the setting is valid until it is cancelled.
- Depending on the usage of the Delicious Freezing Space, more power may be consumed when Delicious Freezing is enabled than when disabled.

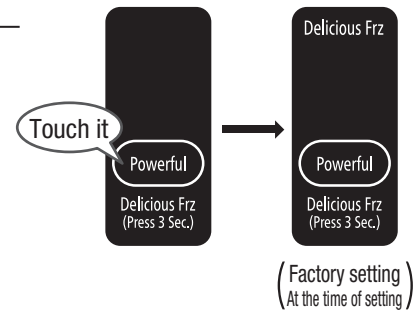

Cancel Touch **MENU** on the Control Panel to turn on the indicator lamp. Press and hold the **Powerful** for three seconds or more until the preset sound (2 beeps) is heard to turn off the “Delicious Frz” indicator lamp.

When you want to freeze food quickly (Quick Freezing)

When you want to freeze a lot of food that you have bought at a time quickly, enhance the ability to cool the Freezer Compartment.

1 Touch **MENU** button on the Control Panel to turn on the indicator lamp.

All indicator lamps turn on, and then the current settings are displayed.

2 Touch **Powerful** button to turn on the “Freezer” indicator lamp.

During “Freezer” mode, “Freezer” indicator lamp is kept ON. [“eco” Operation indicator lamp] is turned off.

The operation will end automatically in about 120 minutes, and “Freezer” indicator lamp will be turned off.



To cancel it Touch **MENU** button on the Control Panel to turn on the indicator lamp, and touch **Powerful** button to turn off “Freezer” indicator lamp.

Notice

- Freezer compartment is cooled preferentially in the “Freezer” operation. For that reason, temperature of the Refrigerator Compartment may rise if the Refrigerator Compartment door is opened/closed frequently.
- Touching **Powerful** button again within 60 minutes after the end of the “Freezer” operation, the lamp is illuminated, but the “Freezer” operation does not start. The operation will start after 60 minutes pass.
- Be sure to wrap a food item with food plastic film or put it in a freezing bag to prevent it from sticking to the aluminum tray.
- When selecting the “Freezer” while the “Delicious Frz” is selected, the “Freezer” operation takes precedence. After the end of the “Freezer” operation, the “Delicious Frz” function is also left enabled.
- More power is consumed during the “Freezer” operation than during the normal operation.

VEGETABLE COMPARTMENT

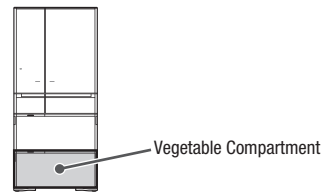

Platinum catalyst
The platinum catalyst decomposes odor ingredients of meat or fish and/or ethylene gas from vegetables into carbon dioxide to maintain the freshness of foods.

Locking handle
(Containing platinum catalyst)
※ Do not remove it.

Upper Case

Lower case

Partition
※ Do not remove it.

Moisture unit
※ Do not remove it.

Moisture Cover
※ Do not remove it.

Partition ※ Do not remove it. (only for R-X730G type)

Tall Storage Compartment

Upper space

Door of the Vegetable Compartment

Partition

Lower space

Notice ● If you move the Moisture Cover forcibly, the Cover may be damaged or you may be injured.

Stored foods

| | |
|---------------------------------|---|
| Upper space | Unfinished vegetables, small vegetables, fruits, etc. |
| Tall Storage Compartment | Tall vegetables, 2L PET bottle, etc. |
| Lower space | Leaf vegetables (spinach, Japanese Mustard Spinach etc.), large vegetables (cabbage, lettuce), etc. |

- Notice**
- In the Upper space, Lower space, or Tall Storage Compartment, the state of preservation may vary due to the amount, variety, or freshness of stored vegetables.
 - Since the Vegetable Compartment is highly humid, dew may be condensed on the surface of the case and the Moisture Unit and Cover.
 - The Tall Storage Compartment may have temperature slightly higher than that of other spaces.
- Request**
- Since the Vegetable Compartment is highly humid, dew may be condensed on the Upper and Lower Cases and the surface of vegetables, depending on the volume or type of vegetables, but it is normal. Water pool, if any, is likely to damage food, so wipe it off with a soft cloth.
 - If the moisture unit is blocked by a bag or container of foods, dew is formed easily. Move out the bag or container of foods from there.
 - If you feel uneasy about dew condensation, wrap the foods.
 - When storing dried foods such as rice, laver and others in the Vegetable Compartment, put them in a sealed container (bag) and then place them in the Vegetable Compartment. Dried foods may absorb the moisture.
 - When the Vegetable Compartment contains a small quantity of vegetables, high humidity cannot be maintained. Wrap a vegetable with plastic food wrap before storing it in the refrigerator.

Caution on how to store foods

- **Do not pile up foods higher than the storage space.**
 - The door may not be closed securely, which leads to inefficient cooling. It may also damage food, the case and the Moisture Cover.
 - Storing a tall food in the Lower Space may prevent the closing of the Upper Case.
 - **Do not use the refrigerator with the Upper Case removed. Doing so may cause food to drop into the rear of the case, which may prevent the closing of the door.**
- **Do not stuff foods or drinks into each space.**
 - Some PET bottle can't be stored, depending on its type.
 - The partition, the cases or the Moisture Cover may be damaged.

Guideline for height

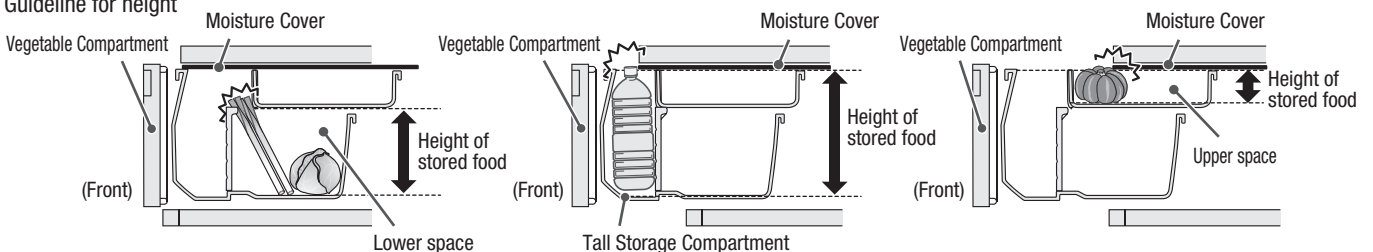

To cool it more [Vegetable Compartment (MAX)]

1

Touch **MENU** button on the Control Panel to turn on the indicator lamp.

All indicator lamps turn on, and then the current settings are displayed.

2

Touch **Powerful** button to turn on “Veg” .

Food is cooled at temperatures lower than usual (Normally, approx. 4°C to 8°C, → “Veg” : 2°C to 6°C)

※ The above temperatures are provided as a guide when the inside temperatures are stabilized at the ambient temperature of 32°C under the conditions that: The temperatures of the Refrigerator and Freezer Compartments are set to “■■■” and the doors are closed without storing food.

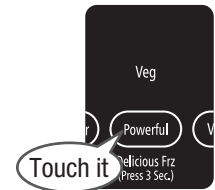

Caution

- For energy saving, the display will be turned off after about 40 seconds, but the setting remains active until it is released. Meanwhile, note that while the “Veg” setting is on, the [“eco” Operation indicator lamp] does not turn on.

To cancel it

Touch **MENU** button on the Control Panel to turn on the indicator lamp, and then touch

Powerful button to turn off the “Veg” indicator lamp.

Notice

- If foods are kept in the “Veg” for a long time, vegetables high in water content may freeze. Release the setting of “Veg” .
- You cannot set both “Veg” and “Freezer” concurrently.
If it is switched to “Freezer” mode during the “Veg” mode, it will not return to the “Veg” mode by itself after “Freezer” is ended automatically. Set it to the “Veg” again.
- When setting “Energy Saving” mode during the “Veg” mode, the cooling function is shifted to weaker cooling effects from the “Veg” . [→ Pg.62](#)
- When the ambient temperature is low, the temperature in the case may be lower.

Request

- If vegetables sensitive to low temperature such as eggplant and cucumber, etc. are stored with the setting “Veg” , they may have pits on the surface or get discolored. In that case, release the setting of “Veg” .
- While it is set to “Veg” , there may be more dew condensation in the Vegetable Compartment. If it is undesirable that dew adheres to the stored vegetables, release the setting of “Veg” .

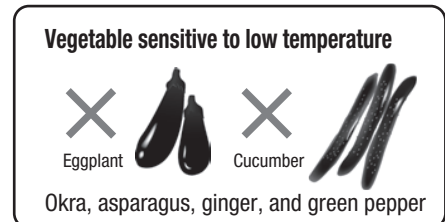

Vegetable Compartment

VARIOUS FUNCTIONS

Setting “Energy Saving” mode

Setting the “Energy Saving” mode reduces the ability to cool each compartment for energy savings.

Likewise, when the door of the Vegetable Compartment is left open for 30 seconds or more, the LED light in the compartment has reduced brightness for energy savings.

If a door is not opened or closed for a long time, the inside is cooled down slowly to further reduce power consumption.

1 Touch **MENU** button on the Control Panel to turn on the indicator lamp.

All indicator lamps turn on, and then the current settings are displayed.

2 Touch **Energy Saving** button to turn on the “Save” indicator lamp.

The Energy Saving mode is set to “Off” (lamp off) before shipping.

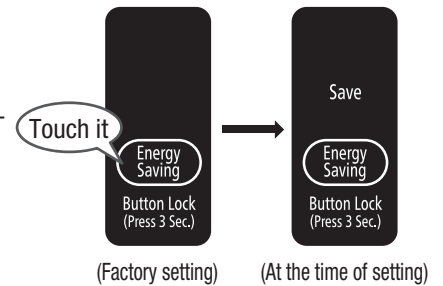

Cancel Touch **MENU** button on the Control Panel to turn on the indicator lamp, and touch **Energy Saving** button to turn off “Save” indicator lamp.

Notice

- Automatic temperature control lowers cooling loads, which may cause ice cream to get soft and frost to form on frozen food. It also requires longer freezing time and ice making time.
- The “Save” indicator lamp is turned on during the “Energy Saving” mode.
- When “Quick”, “Freezer” is set in the Energy Saving mode, the Energy Saving mode is temporarily cancelled, and restored after the completion of the quick operation.
- When both “Save” and “Veg” modes are set concurrently, the cooling function will be weakened from the “Veg”. → Pg.61
- When the temperature of the “Freezer Compartment” and/or “Refrigerator Compartment” is set to “■”, the minimum level of cooling is not reduced to maintain the freshness of foods.

“eco” Operation indicator lamp

During energy saving operation, as in Frost Recycling Cooling, [“eco” Operation indicator lamp] **eco** is automatically turned ON to indicate the energy saving operation.

Open or close a door less frequently and quickly. Use this indicator wisely to save energy efficiently.

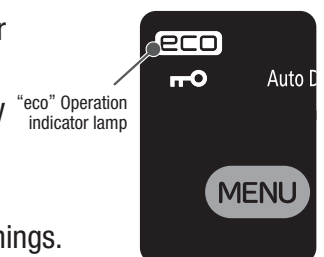

Notice

If [“eco” Operation indicator lamp] isn’t illuminated, check the following things.

- Immediately after it is installed, or plentiful foods are stored at a time
- If the door is frequently opened / closed (when the [Door Open & Close indicator lamp] is lit)
- If the door is not closed completely because some food/bag is wedged between the door and the body of the refrigerator.
- “Freezer”, “Quick” or “Veg” is set.
- The ambient temperature of the refrigerator is about 35°C or higher.

Door Open & Close indicator lamp

When a door is opened or closed frequently, the [Door Open & Close indicator lamp] **Door** is automatically lit.

Open or close the door less frequently and quickly. Use this indicator wisely to save energy efficiently.

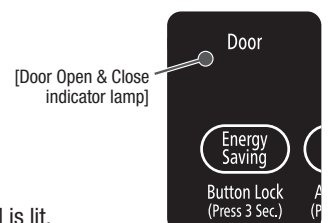

Notice

- The [Door Open & Close indicator lamp] is turned off automatically after about 5 minutes.
- The [“eco” Operation indicator lamp] remains unlit when the [Door Open & Close indicator lamp] is lit.

Locking the Control Panel

Disabling operations can prevent erroneous operations or misuse by children.



When this indicator lamp  (Lock of the Control Panel) is illuminated, any other portion of the Control Panel will not be activated by touching it.

1 Touch button on the Control Panel to turn on the indicator lamp.

All indicator lamps turn on, and then the current settings are displayed.

2 Press down button for 3 seconds or more until the preset sound is heard.

Lock of the Control Panel is changed to "On" or "Off" .
The locking of the Control Panel is factory-set to "OFF" (" " is unlit).

| Setting of the Control Panel's lock | "On" (locked) | "Off" (unlocked) |
|---|--|------------------|
| "  indicator lamp" | On  | Off |
| Preset sound | Long beep | 2 beeps |

Notice

- The Auto Door function will not be disabled even when the Control Panel is locked. In order to stop Auto Door function, unlock the Control Panel, and touch the  button for 3 seconds or more until it beeps twice.
→ Pg.50, 51
- When connecting/disconnecting the power plug or after recovering from electric power failure, lock of the panel for operation may be released.

Door Alarm

If any door is kept opened for 1 minute or more, it is notified with sound or light.

For R-G670G type, R-G620G type, no Door Alarm is installed in the Upper Freezer.

| Duration when door is open | 1 minute | 2 minutes | From 3 minutes onward |
|----------------------------|---------------------|---------------------|----------------------------------|
| Alarm sound | Long beep (3 beeps) | Long beep (5 beeps) | Long beep (continuously), Louder |
| Display area | Blinking | Blinking | Blinking |
| For operation | Light ON | Light ON | Light ON |

- Door alarm is also raised when a door is left open for 30 seconds or more in the energy saving mode. The Display Section starts to blink after one minute from the opening.
- While the indicator lamp is blinking on the display area, the Control Panel remains inactive upon touching.

Door Alarm and volume adjustment of the operation sound

You can set the sound level of the alarm louder or no alarm sound.

1 Touch button on the Control Panel to turn on the indicator lamp.

All indicator lamps turn on, and then the current settings are displayed.

2 Press down button for 3 seconds or more until the preset sound is heard.

The volume level of the operation sound is changed from "Standard" to "Louder" or "Sound off" . Repeat the change of settings to set the operation sound you like (see the table shown below). The sound is set to "Standard" before shipping.

| Volume level | Standard | Louder | Sound off | Standard |
|--------------|----------|----------------|-------------|-----------|
| Preset sound | — | ➡ 2 long beeps | ➡ Long beep | ➡ 2 beeps |

(Factory setting)



Notice

- It is impossible to adjust the volume level of either door alarm or operation sound only.
- When the Door Alarm is disabled, characters on the Control Panel no longer blink.
- Even if the volume level is set to "Sound off" , the alarm of the Ice Maker Cleaning is raised and the operation sound is heard when the Auto Door is set to "ON" .
- When connecting/disconnecting the power plug or after recovering from electric power failure, it will return to the standard setting where the Door Alarm sounds.

VARIOUS FUNCTIONS (CONTINUED)

Set the condensation prevention heater to MIN. (Swing partition)

Setting the condensation prevention heater to MIN saves energy.

When dew is formed in the swing partition, set it to the standard.

The temperature settings for the swing partition can be adjusted by three levels (1 to 2), and level 2 is the most energy saving.

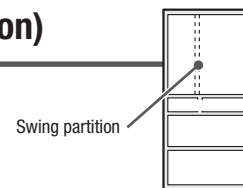

| | | | | | | | |
|----------------------------------|----------|---|---------------------|---|---------------------|---|----------|
| MIN setting of the heater | Standard | ➔ | MIN setting level 1 | ➔ | MIN setting level 2 | ➔ | Standard |
| Preset sound | — | | Long beep | | Long beep (2 beeps) | | 2 beeps |

(Factory setting) ↖ ↗

Setting the swing partition

- 1** Open the door of the Lower Freezer Compartment.
- 2** Touch **MENU** button on the Control Panel to turn on the indicator lamp.
All indicator lamps turn on, and then the current settings are displayed.
- 3** Press down **Powerful** button for 3 seconds or more until the preset sound is heard.
The setting of MIN level of the dew condensation prevention heater will be switched on.
Repeat the above-stated operation to set it to the level you prefer (see the table above).
- 4** Close the door of the Lower Freezer Compartment.

Notice

● The setting will be returned to the standard when the power plug is disconnected and connected or power failure recovery takes place.

Fine adjustment of the temperature (Refrigerator Compartment / Freezer Compartment)

Temperature settings for Refrigerator and Freezer Compartments can be more finely adjusted by 11 levels.

- 1** Open the door of the Lower Freezer Compartment.
- 2** Touch **MENU** button on the Control Panel to turn on the indicator lamp.
All indicator lamps turn on, and then the current settings are displayed.
- 3** Press down **Fridge** button for 5 seconds or more until 1 beep is heard.
- 4** Close the door of the Lower Freezer Compartment.
- 5** Touch **Fridge** or **Freezer** button to make an adjustment.

Each time you touch the button, the corresponding indicator lamp changes in the order shown below. Usually it is recommended to use it at the setting of "■■■".

(Lighting Blinking Turned off)

| | | | | | | | | | | | |
|-----------------|---------------|-----|---|---|---|------|---|---|---|-----|--------------|
| Indication lamp | | | | | | | | | | | |
| Setting | MIN and under | MIN | → | → | → | MID. | → | → | → | MAX | MAX and more |



- To cancel** Follow the operations shown in Step 1, 2, 3 and 4.

2 beeps sound and you can set the temperature by normal step (3 levels).

Triple Power Deodorizing Effect

A combination of 3 types of deodorizing materials leads to deodorizing various odorous substances in the refrigerator including 4 major odors such as sulfur, nitrogen, aldehyde and oxidization odors. Activities of bacteria collected by the filter are also restricted.

Deodorant filter has the effect of sterile filtration.

- Testing laboratory: Boken Quality Evaluation Institute, a general incorporate foundation ● Test method: Film contacting method (JIS Z 2801)
- Name of the part used for treatment: Filter ● Sterilization method: applying oxidation catalyst to the filter ● Target: bacteria collected by the filter
- Test result: sterilization effect of 99 % after 24 hours by using a filter only. This does not always have effect on the entire refrigerator or foods.

MAINTENANCE



Warning

- Make sure to unplug the power plug when maintaining the refrigerator.

■ When dirt is found

- Wipe off it immediately. It is recommended to clean the hidden places once a year.

Power plug Once or twice a year

1

Unplug the power cord from the outlet.

If the dust on the power plug remains not cleaned, it may cause a fire.



2

Check the following matters.

- Is any damage found on the power cord?
- Does the power plug become hot?
- ※ If there is any abnormality, please consult with your dealer about it.

3

Remove the dust and wipe it with a dry cloth.



4

Connect the power plug firmly to a power outlet.



The back/floor of the refrigerator Once or twice a year

1

Pull the leg cover and remove it.

Push it in from the front when installing it.

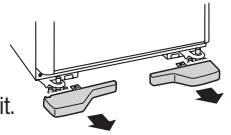

2

Float the Adjustable mounts from the floor and draw the refrigerator straight.

Lay the protection board etc. on the floor which can be easily scratched.

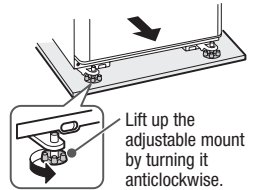

Lift up the adjustable mount by turning it anticlockwise.

3

Wipe off dirt on the back of the refrigerator, duct on the side, wall and floor.

The back of the refrigerator easily becomes dirty because fine dust is accumulated on it by convection of air.

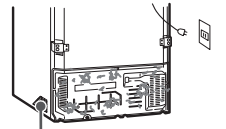

Duct on the side

Vacuum Compartment Once a month

1

Pull out the Vacuum Case.

For how to remove, (→ Pg.70)

Be sure to remove foods contained in the Vacuum Case.

2

Wipe off following parts with a soft cloth which is steeped in lukewarm water.

- ※ Do not use the detergents, etc.

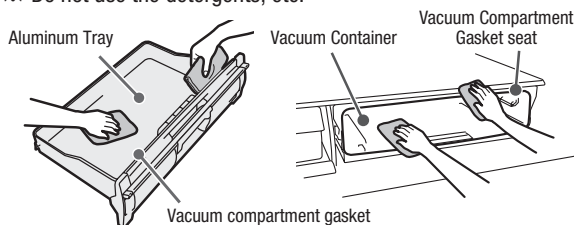

Request

- Wipe the ceiling of the compartment (platinum catalyst and LED light) gently. Failing to do so may cause damage.
- If detergents and others except lukewarm water are used to clean the vacuum compartment gasket, the vacuum compartment gasket may be damaged, deformed or change in color, which may cause the vacuum state unable to keep well.

3

Attach the Vacuum Case.

For how to attach, (→ Pg.70)

Loosened vacuum compartment gasket or loose-fitting door of the Vacuum Case may cause the vacuum state unable to keep well.

When the Vacuum Compartment Gasket is dirt

1

Remove the vacuum compartment gasket from the Vacuum Case.

Grasp the tab of the vacuum compartment gasket on the observer's upper right and remove it by hand carefully.

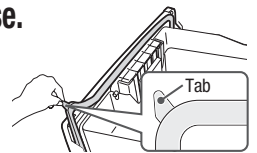

2

Rinse dirty portion in water using a soft sponge, etc.

- ※ Do not use the detergents, etc.

3

Wipe off excess moisture with a dry cloth and dry it out naturally.

4

Wipe off dirt in the vacuum compartment gasket mounting groove.

Groove for attaching the vacuum compartment gasket.

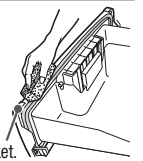

5

Attach the vacuum compartment gasket.

Align the tab to the notch accurately, and then combine them together.

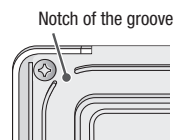
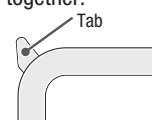

Auto Drawer

Clean the auto door unit when food falls onto or is caught in the upper part of the auto door unit and when liquid is deposited on the auto door unit.

- 1** Unplug the power plug.
- 2** Remove each case of the Lower Freezer or the Vegetable Compartment. → Pg.71
- 3** Remove all foods which drop or are caught in.
- 4** Wipe off deposited liquid using a soft and dry cloth.

Caution

- Make sure that water never splash to the Auto Drawer unit. Otherwise, it may cause malfunction.
- Do not disassemble the Auto Drawer unit. Otherwise, it may cause injury and/or malfunction.
- Exercise caution not to move the linkage section. Failing to do so may cause a failure.



Warning

- Make sure to disconnect the power plug from the power outlet before starting maintenance to avoid injury.

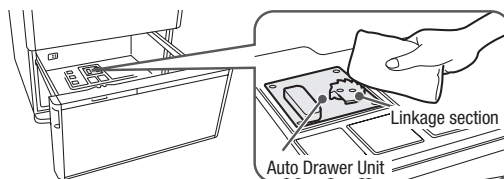

Surface of door Once a month

Wipe the surface of door using a soft cloth wet by lukewarm water, and then wipe off water with a dry cloth.

Remaining adhesives on glass surfaces, if any, can be removed clearly by using a plastic eraser to rub it and then wiping it off with a dry cloth.

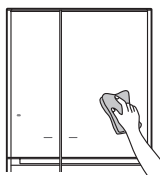

Each shelf/pocket/case Once per three months

Use a soft cloth wet by lukewarm water to wipe off.

For how to remove → Pg.70, 71

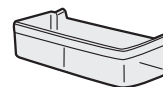

Request

- When the lower case of the Vegetable Compartment is washed with water, turn it upside down to drain water, and then wipe off water with a dry cloth. Don't use thick-pile toothbrush or scrubbing brush to wash. It may cause damage to case or moisture unit.

Door gaskets Once a month

Wipe it thoroughly because it can easily become dirty.

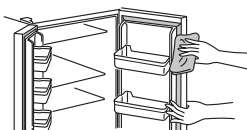

Liquid receivers Once a month

Wipe them off if liquid collects and/or they become dirty.



Caution

- Do not use the following items because it may cause damage and discoloration of the door, paintwork, plastic parts and glass surface
 - Alkaline and alkalescence detergent for kitchen, plate powder, powder soap, oil, hot water, scrubbing brush, acid, benzine, thinner, alcohol, and bleach, etc.
- When using a chemical dustcloth, follow its instructions.
- Make sure to wipe off spilled cooking oil, citrus fruits juice and food soup, because it may cause damage and discoloration of the door, paint work and plastic parts.
- Do not wipe off lubricant applied to movable contact surfaces of cases and rails for the slide door.
- When a magnet or suction cup is attached on the side surface of the body or the surface of a door, it may leave some mark.
- When unplugging the power plug, the settings of the Control Panel may be released. So check the settings.

MAINTENANCE (CONTINUED)



Warning

- Do not place your hand in the mechanical section of the automatic ice maker.
(Rotation of the ice tray may cause injury.)

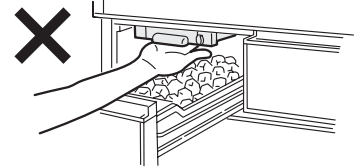

Ice Maker Cleaning

When using for the first time

When not used for more than one week

Wash the Ice Tray or water paths with water.

Preparation

Be sure to check the followings before starting the operation.

Water supply container

- Water is filled in it up to the limit line.
- It is set correctly beyond the tank set position line.

Ice case

- If there remains ice, remove it.

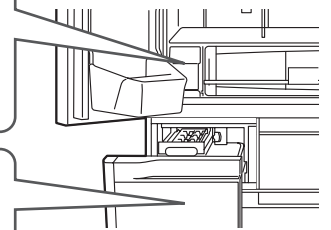

Go to the next step after checking them.

1

Close all the doors.

2

Touch **MENU button on the Control Panel to turn on the indicator lamp.**

All indicator lamps turn on, and then the current settings are displayed.

3

Hold down **Ice Maker button for 5 seconds or more until the alarm sounds.**

When the 3 indicator lamps “Quick”, “On” and “Off” start to blink and alarm starts to sound, stop holding the button.

“Ice Maker Cleaning” starts (for about 4 minutes).

- The indicator lamp will flash and the buzzer will sound for about 4 minutes.
- “Ice Maker Cleaning” can't be interrupted.
- If you open any of the refrigerator doors during Ice Maker Cleaning, the cleaning may not work properly. Do not open or close the door until cleaning is completed.
- Door alarm sounds even if alarm is disabled. → Pg.63

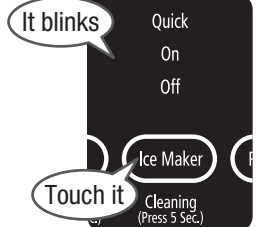

4

Place a clean towel, etc. on the bottom in the Ice Case so that the cutout of the Ice Case can be blocked after the alarm and blinking of the indicator lamp end.

Place a water-absorbing towel on the bottom in the Ice Case to prevent trapped water during the ice maker cleaning from spilling out of the cutout of the Ice Case.

R-X730G type

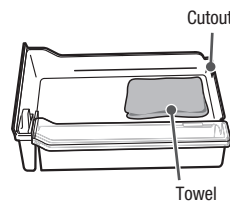

R-X670G type, R-G670G type, R-G620G type

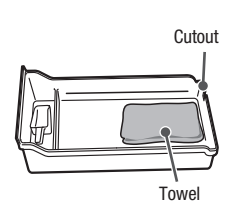

5

Wipe off water inside the Ice Case completely, and then set it to the Ice Compartment.

Remove the towel with which you have wiped off water.

There is no problem with using water remaining in the water supply container, if any.

After “Ice Maker Cleaning”, it is set to “On” mode, etc.

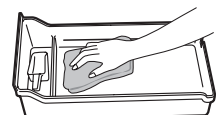

Water supply container Once a week

1 Remove the water supply container, and then the lid.

Take up the rear side of the lid toward in the direction of the arrow, and then remove it.

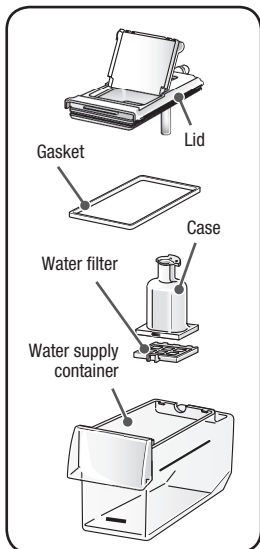
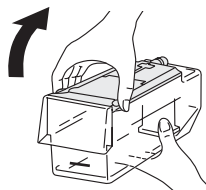

2 Remove the gasket from the lid and then the case.

Turn the case and remove it from the lid.

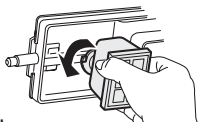

3 Remove the water filter from the case.

Pinch the tab of the water filter with fingers to unset it from the fork, and then remove the case.

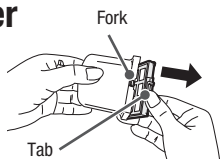

4 Rinse each part of the water supply container in water.

Wash it with a soft wash sponge etc. Do not use the detergents etc.

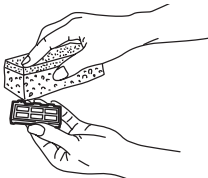

Request

- Dry out the water filter to prevent molds and gunk.

Notice

- Replace the water filter normally every 3 - 4 years.
→ Pg.77

5 Attach each part to the water supply container, pour water in and then set it.

Insert the lid from its rear side and close it in the direction of the arrow.

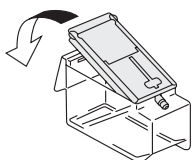

Notice

- Dechlorinated water such as mineral water, well water, filtered water, cooled boiled water and others tends to cause water stain / slime compared with tap water. So it is recommended to maintain once every 3 days.
- When the Ice Maker is not used for more than 1 week, dry out the water supply container, and then set it in place (dry out the water filter, among others).
When not used for more than 1 week, it is recommended to start Ice Maker Cleaning before use. → Pg.68

Ice tray Once or twice a year

1 Touch **MENU** button on the Control Panel to turn on the indicator lamp.

All indicator lamps turn on, and then the current settings are displayed.

2 Touch **Ice Maker** button to turn on "Off" indicator lamp.

It stops water supply to the ice tray.

※ When "Off" indicator lamp blinks, wait for about 1 minute for it to turn on, and then follow the next steps.

Note that the frame cannot be pulled out.



3 Open the door of the Ice Compartment, and take out the ice tray.

1 Push the level laterally. 2 draw the frame.

3 Raise the cover (▲ part) in the direction of the arrow.

4 Remove the ice tray from the frame.

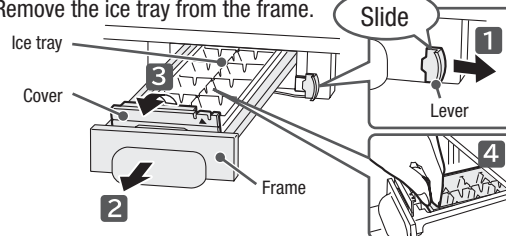

4 Empty the ice tray and wash it lightly in the stream.

Do not use a sponge / cleanser, etc. Be sure not to scarify.

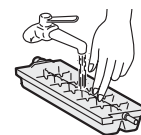

5 Open the Ice Compartment, and then attach the ice tray.

1 Set the ice tray

2 Hold down the cover to the end until it snaps.

3 Push the frame to the end until it snaps.

4 Move the frame back and forth to check that it is fixed securely.

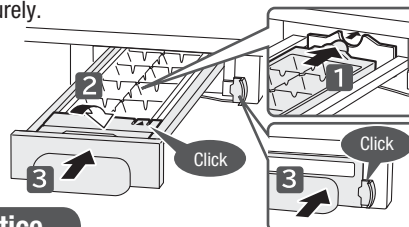

Notice

- When the frame for the ice tray cannot be pushed into the back, the motor that drives the ice-tray may have operated. Remove the ice tray once and then push the frame alone into the back, and then touch **Ice Maker** button with all the doors closed to turn on "Off". After 1 minute, the ice-tray driving motor gets ready, allowing you to mount the ice-tray.

6 Touch **MENU** button on the Control Panel to turn on the indicator lamp, and then touch **Ice Maker** button to turn on the "On" indicator lamp. Automatic Ice Making starts.

HOW TO REMOVE/ATTACH PARTS

Caution

- Before removing parts, take out all the foods on the parts.
 - Do not remove parts except the ones listed here.
- Please contact with a Hitachi customer service centre for cleaning such parts after removing them.

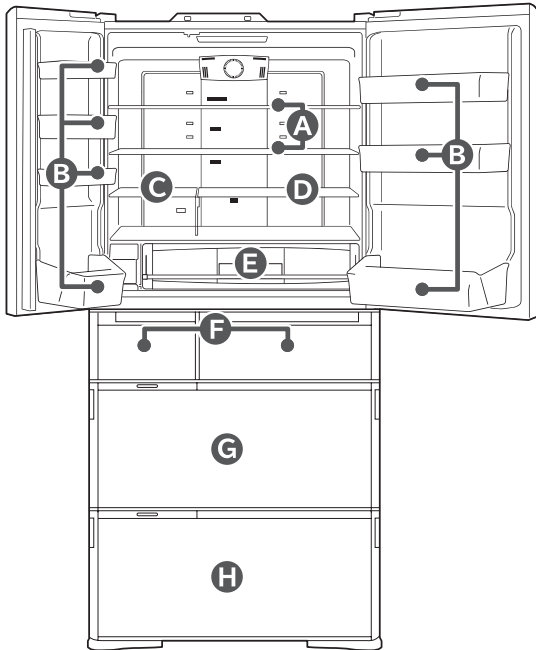

A Height adjustable upper and middle shelf

- 1 Slightly lift up the back of the shelf and draw it.
- 2 Raise the shelf, as shown in the drawing.
- 3 Rotate and remove it.

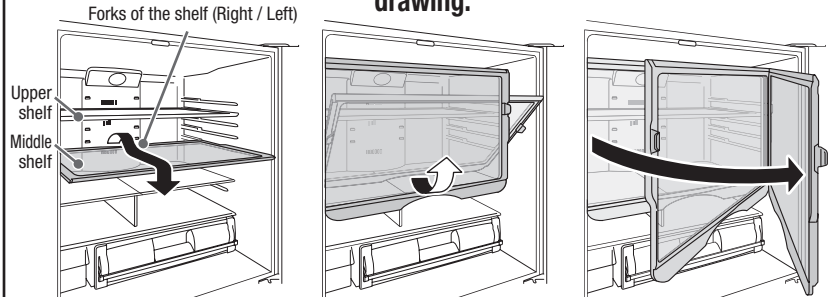

When installing the shelf, slide it until it reaches to the interior wall, then slightly lift up the back of the shelf and push it in.
(hitch the forks of the shelf to the parts on the back of the shelf)

Notice

Door may be damaged if you draw the shelf without turning it.
Be careful to attach/remove the glass shelf because it is heavy.
If it drops, it may break and cause bruise or injury.

Request

Before removing the upper shelf, remove the middle shelf.

B Door pocket

Lift up the door pocket while tapping the left/right of its bottom surface, and remove it.
(It is fixed a little tightly.)

Caution

Insert the door pocket fully to the end when installing it.
If it drops, it may break and cause bruise or injury.

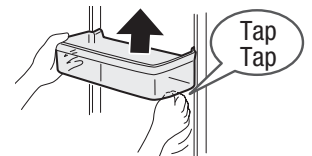

C Fixed shelf

Draw the shelf, and pull off the 2 pins on the lower right and remove it.

R-X670G type, R-G670G type

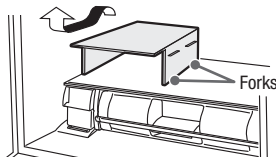

R-X730G type, R-G620G type

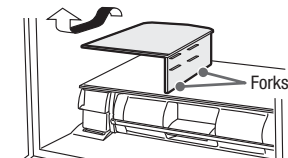

D Height adjustable lower shelf

Remove the shelf by slightly lifting up the rear of the shelf.

R-X670G type, R-G670G type

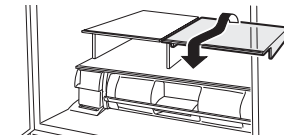

R-X730G type, R-G620G type

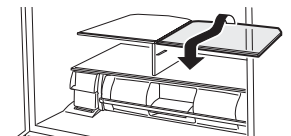

Caution

If you pull out the shelf straight, it may hit the door.

E Vacuum Case

How to remove

Pull out the Vacuum Case by slightly lifting up and moving up and down.

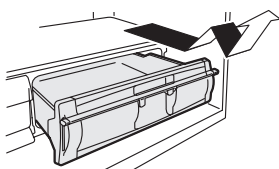

How to attach

Insert the Vacuum Case so that both right and left convex ribs on the case can slide under the guide rail of the Vacuum Container.
Lastly, hold down the handle to lock.

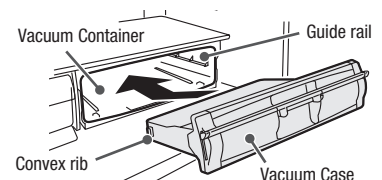

Request

Check if it is fixed properly by taking it in and out a few times.

F Ice Case (Ice Compartment) • Upper Freezer case (Upper Freezer)

Draw the door fully and lift up the case towards you.

Put the case bottom on the frame and set the case.

- Before taking out the Ice Case of R-X730G type, close the lid of the Small Article Case by pulling it to the front.

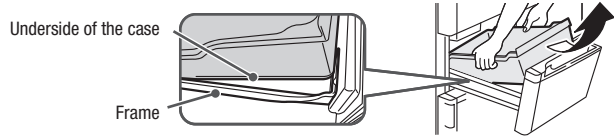

[Only R-X730G type]

Remove the lid of the Small Article Case as follows:

(Mount it in the reverse order of removal)

- 1 Slide the lid halfway and deflect the side of the Ice Case to remove the fork.**

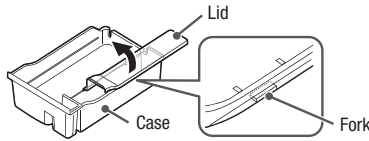

- 2 Slide the lid toward the rear and pull it out.**

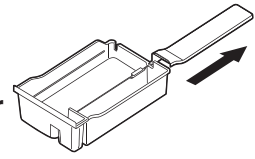

G Slide case and lower freezer case (Lower Freezer)

- 1 Draw the door fully, and draw the Slide case respectively.**

Caution

- Do not remove the Slimline slide case.

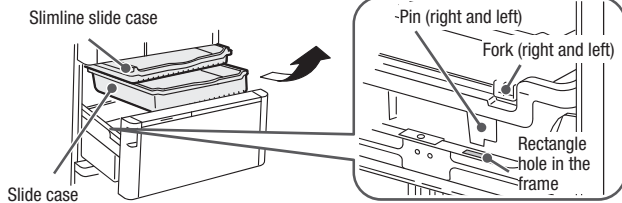

- 2 Lift up the Lower freezer case.**

Caution

- The partition of the Lower Freezer can't be removed.

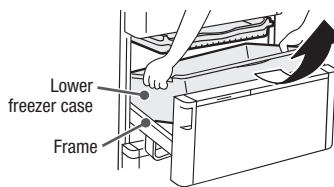

Caution

- Do not peel off the adhesive seal.

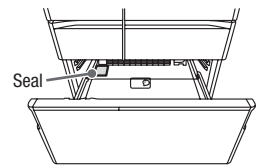

When installing it, insert the pins on the left/right of the Lower freezer case into the square holes on the frame to install it. Moreover, hitch the fork on the left/right of the Slide case to the outside of the Lower freezer case.

H Upper Case, Lower Case (Vegetable Compartment)

- 1 Draw the door fully and pull up both hands further to pull it out slowly and to place it on the floor.**

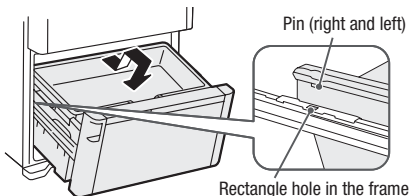

- 2 Lift up the Upper Case.**

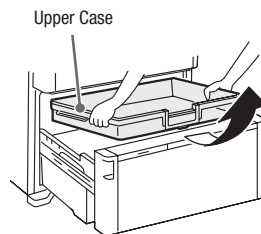

- 3 Lift up the Lower Case toward the front.**

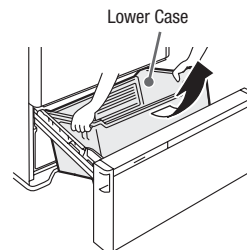

Request

- Be careful. Water may drip from the backside of the lower case.

Request

- Do not detach the door completely.
- When opening the door, do not place your foot near the door. Doing so may cause it to be caught between the door and the floor.

To install the Lower Case, put the lugs on the right and left of the lower case into the square holes on the frame, and place the fringe of the lower case on the frame to set.

Wrong setting may cause abnormal noise or half-closed door when opening or closing the door.

Request

- The partition cannot be removed.
- Improper installation of the Upper Case may damage parts, including cases. Once the Upper Case is installed, slide it in the front-rear direction to confirm that it is mounted properly.
- Do not remove the Moisture Cover and Unit in the Lower Case.

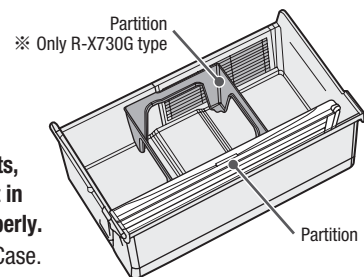

How to attach the slide door (Ice Compartment/Upper Freezer/Lower Freezer/Vegetable Compartment)

Ice Compartment/Upper Freezer

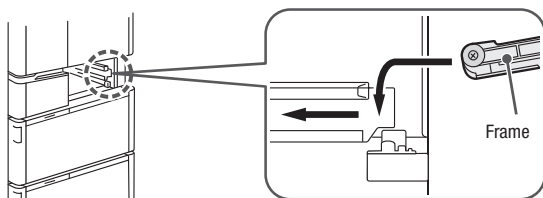

Lower Freezer/Vegetable Compartment

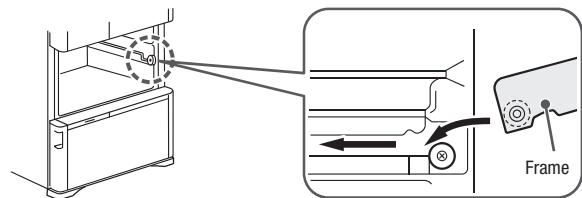



TROUBLESHOOTING



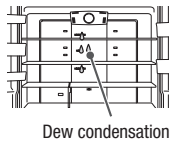

Check the following points before asking repair. Contact your dealer or our customer center if the problem still exists after checking them.

| | When this happens | Check Item | Action and Reasons |
|--|--|--|---|
| Initial stage | Not cooled well. | Have 24 hours passed since the installation? | Cooling may take more than 24 hours at installation. Place food at appropriate intervals, refrain from opening and closing a door as much as possible and wait. Cooling takes more time during summer or in case of a lot of food being stored. |
| | No ice is made. | Have 24 hours passed since the installation? | As the entire refrigerator is not cooled immediately after installation, it takes more than 24 hours for the first ice to be made. Place food at appropriate intervals, refrain from opening and closing a door as much as possible and wait. |
| Control Panel | The Control Panel does not respond. | Is LOCK lit in the Display Section? If so, the Operation Section is locked. | Cancel the lock of the Control Panel. (→ Pg.63) |
| | | Is Refrigerator Compartment Door open? | Operate after closing it. |
| | | Is a water drop or dirt attached to the Control Panel? | Wipe off dirt with a wet cloth and then wipe off moisture with a dry cloth. |
| | | Are you wearing gloves or applying a plaster? | Touch directly with your finger. |
| Control Panel | The Operation Section is unlit. | Did you touch adjacent Control Panel wrongly? | Touch the target Control Panel only. |
| | | _____ | The Operation Section goes out about 40 seconds after the completion of operation for energy savings. (→ Pg.47) |
| | | _____ | To turn it on, touch MENU or open a door of the Refrigerator Compartment. |
| | | _____ | |
| Automatic ice making | Ice cannot be made at all. | Is "Off" lit in the Display Section? Ice making is set to Stop Ice Making. | Set it to "On" or "Quick" mode. (→Pg.56, 57) |
| | | Is "Water" lit in the Display Section? The water in the water supply tank is low. | Pour water into the water supply container. (→Pg.56, 57) |
| | | Is the water in the water supply tank low? | If the water in the tank is low, ice may not be made. Add water until water level reaches to the "Container-full line" of the water supply container. (→ Pg.56) |
| | | Is the water supply container pushed firmly until it is beyond the "Container set position" line? | Push it beyond the "Container set position" line. (→ Pg.56) |
| | | Do you push it to the end until it snaps? | Push the frame back until it snaps. (→ Pg.69) |
| | | Is anything other than ice stored in the ice case? | Remove it from the Ice Case. |
| | It takes a long time to make ice. | Is the ice case filled with ice over the limit line of stored ice amount? | Level the ice. (→ Pg.57) |
| | | Do you open the door frequently or store a large amount of food at a time? | The inside is not cooled down enough. Minimize the number of times of opening and closing the door until it cools fully. Allow clearance as much as possible between each stored food. |
| | | Is the surrounding temperature low? | Ice making takes more than four hours during winter. Refrain from opening and closing a door as much as possible and wait. |
| | | Have you just changed the setting from "Off" to "On"? | Ice-making may take time immediately after changing the setting. Refrain from opening and closing a door as much as possible and wait. |
| | | Does any food or package caught in the door of the Freezer or Ice Compartments prevent the door from closing completely? | Remove caught food, if any, and close the door securely. |
| | Projection is generated on ice. | Is the "Energy Saving" mode "ON"? | Exit the "Energy Saving" mode. (→ Pg.62) |
| | | _____ | It is frozen water collected in the ice tray groove. It does not indicate any trouble. |
| | Stored ice becomes small. Ice sticks together. | Is old ice left unused for a long time? | The old ice cubes become smaller by themselves and may cling to each other. |
| Do you open the door frequently or store a large amount of food at a time? | | Open/close the door quickly or reduce frequency of opening and closing the door. | |
| Has a door of the Refrigerator Compartment or the drawers incompletely closed temporarily? | | Close the door completely. | |
| Small ice is made. | Is the water in the water supply tank low? | If the water in the tank is low, ice may not be made. Add water until water level reaches to the "Container-full line" of the water supply container. (→ Pg.56) | |
| Connected ice is made. | Is the frame pushed inside until it clicks into place? | Push the frame inside until it clicks into place. (→ Pg.69) | |
| | Is the Ice Tray damaged? | A damaged Ice Tray precludes the removal of ice cubes from the Ice Tray, resulting in broken ice cubes or ice cubes sticking to each other. Contact your distributor for the replacement of the Ice Tray. | |
| | _____ | Water in the groove in the Ice Tray may be frozen and sticks to ice cubes. It does not indicate any trouble. | |
| There is white impurity in ice. | Did you use mineral water to make ice? | It is because the fine air bubble in water is contained in ice. Mineral contained in water may freeze and become white impurity in ice. It may remain after thawing in water, but it is harmless. | |
| Ice tray frame cannot be drawn. | Is "Off" set? | The ice tray cannot be drawn when the auto ice maker is operating. Set it to "Off". When the "Off" indicator lamp is blinking, wait for 1 minute until "Off" is lit, and then draw the ice tray. (→ Pg.69) | |
| When you do not make ice | _____ | Set "Off". See "Stop Ice Making". (→ Pg.57) | |

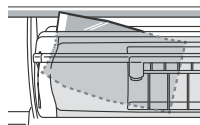
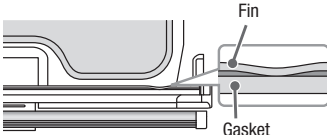
| | When this happens | Check Item | Action and Reasons |
|--|---|---|--|
| Refrigerator does not cool | Is not cooled down. Ice cream is soft. | Does any food or package caught in the door prevent the door from closing completely? | Remove caught food, if any, and close the door securely. Pay attention to the height of food when placing it in the refrigerator. |
| | | Is food squeezed in? or Is a large amount of food put in at one time? | Allow clearance between each food in each compartment. |
| | | Is the case in each compartment fixed securely? | Install them correctly. (→ Pg.71) |
| | | Food cannot be cooled enough, depending on the installation place or surrounding situation. | Check to see if the refrigerator is installed properly. (→ Pg.48) |
| | | Is the "Energy Saving" mode "ON"? | Exit the "Energy Saving" mode. (→ Pg.62) |
| | | Is the temperature set to "■"? | Switch the temperature setting of the compartment where it does not fully cool to "■■■" or "■■■■". (→Pg.52, 58) |
| | | Does the temperature around the refrigerator become high due to weather (ex: in summer)? | Switch the temperature setting of the compartment where it does not fully cool to "■■■■". (→Pg.52, 58, 61) |
| | | Have you left a door open for a long time or opened or closed it frequently? | Temperature in the refrigerator rises little by little while its door is open. If the door is opened/closed frequently or left open for a long time, temperature cannot easily lower. Reduce the number of times of opening and closing the door, or open/close the door quickly. |
| | Is the indication on the Control Panel changing quickly? | The refrigerator is in the demo mode. Please cancel the mode. (→ Pg.73) | |
| Frost and/or dew occurs | Frost, dew or ice adheres to the inside of the refrigerator or the frame of the drawer. | Was the door or the drawer not temporarily shut completely? | Check that any food or package caught in the door, and then close it completely. |
| | | | When a door is opened or closed, water in the air may cling to the walls or parts in the Freezer in the form of frost or ice. Open or close the door quickly, or reduce frequency of opening and closing the door. Wipe off the frost or dew with a dry cloth. |
| | Dew adheres to the outside of the refrigerator. | Is the air surrounding the refrigerator humid? | Dew may adhere to those parts when the indoor humidity is high (ex: rainy day). Wipe off the dew with a dry cloth. |
| | | Is the heater for preventing dew condensation set to Low? | When the air surrounding the refrigerator is humid, dew may be formed. Set the heater for preventing dew condensation to Standard. Wipe off the dew with a dry cloth. (→ Pg.64) |
| | Is the temperature set to "■■■■"? | When the temperature is set to "■■■■", dew may be formed on the surface of a door. Set the temperature to "■■■". Wipe off the dew with a dry cloth. | |
| | Dew condensation occurs in the Refrigerator Compartment. | Have you left a door open for a long time or opened or closed it frequently? | Condensation may form on the wall and/or around the cold air blowout port when the door is opened and closed frequently or the humidity is high around the refrigerator. No trouble. Wipe it off with a dry cloth.  Dew condensation |
| Refrigerator cools overly | Refrigerator cools overly. Food freeze. | "■■■■" is selected in the temperature setting. | Switch it to "■■■". (→Pg.52, 58) |
| | | The surrounding temperature is lower than 5°C. | When the ambient temperature is low, the inside of the refrigerator may cool overly. Switch the temperature setting to "■". |
| | | Is it placed in front of the Cold Air Blowout Port? | Do not place any food in front of the cold air blowout port. |
| [E] display on the control panel flashes | [E] flashing | How many times in succession has it blinked? In what pattern does it blink? | It indicates an abnormal condition. Consult your dealer. |
| | On flashing | Did you put food or ice other than that made by the Automatic Ice Maker in the Ice Compartment? | Some foods, etc. may come into contact with the ice tray. Empty the Ice Compartment and do the "Ice Maker Cleaning". (→ Pg.68) |
| | -1°C flashing | Have you just had your service staff member inspect your refrigerator? | It may be in the operation check mode for serviceman. It will return to the normal mode after about 15 minutes. There is no problem with using the refrigerator. |
| | Auto Door flashing | Have you just had your service staff member inspect your refrigerator? | It may be in the operation check mode for serviceman. It will return to the normal mode after about 10 minutes. There is no problem with using the refrigerator. |
| | Quick On Off All indicator lamps flash | Have you held "On" for five seconds or more? | It is in process of Ice Maker Cleaning. The blink will stop in about four minutes. Do not open any door of the refrigerator during blinking. |
| | Off flashing | Have you just set "Off"? | The Automatic Ice Maker is working. Blinking stops in about one minute. The frame of the Freezer cannot be removed during blinking. |
| | All displays flashing | Is the door opened? Is the door closed incompletely due to food being caught? | Close a door when it is open. If a door is closed incompletely due to food being caught, remove the caught food and close it securely. |
| | | Blinks other than those above | Consult your dealer. |
| | The indication on the Control Panel is changing quickly. | The refrigerator is in the demo mode. Please cancel the mode. In the demo mode, the refrigerator does not perform the cooling operation. Open the right and left doors of the Refrigerator Compartment and the door of the Lower Freezer. Touch [MENU] on the Control Panel to turn on the indicator lamp. Press and hold the [Freezer] button for 10 seconds or more until the preset sound is heard. All the indicator lamps are lit for a few seconds, the demo mode is cancelled and the cooling operation is started. Close the right and left doors of the Refrigerator Compartment and the door of the Lower Freezer. | |

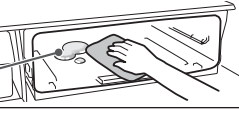
TROUBLESHOOTING (CONTINUED)

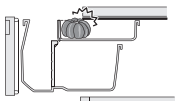
| | When this happens | Check Item | Action and Reasons | |
|--|---|--|--|---|
| Abnormal operating sound is generated | Another door opens after closing 1 door. | Have you shut the door with a bang? | Another door may open for a moment by the wind pressure because cool air path connects each compartment. | |
| | Annoying sound is generated by the refrigerator. | Is the floor unlevel? | Lay a firm board and then install the refrigerator thereon. (→ Pg.48) | |
| | | Does the refrigerator come in contact with the wall or furniture, etc.? | Install the refrigerator with clearance around it. | |
| | | Is the refrigerator cooled down enough? | You may feel that the operation sound is loud because the compressor operates in high-speed under the following conditions: the refrigerator does not cool fully on the occasion such as using it for the first time, opening/closing the door frequently, the surrounding temperature is high. | |
| | | Is "Freezer" and "Quick" set? | When it is set to "Freezer"/"Quick", operation sound of the compressor or the fan motor gets louder because of high-speed revolution. | |
| | Operation sound lasts long. | _____ | As the compressor operates slowly for energy savings, you may hear an operating noise for a long time. | |
| | Operation sound sometimes becomes louder. | _____ | The operating power varies in response to changes in the inside temperature of the refrigerator, and thus you may sometimes hear a large noise. | |
| | When other sounds such as shown in the right table are generated by the refrigerator. | Sound like water flowing (trickling) Sound like collision (tapping) Sound like water boiling (bubbling up) Sound like meat roasting (sizzling) | | These sounds are caused when the refrigerant flows or water flows/ evaporates to remove frost. This is not malfunction. |
| | | Sound like squeaking (cracking) (knocking) | | This sound is heard when the parts squeaks due to changes in temperature in the refrigerator or atmospheric pressure in the Vacuum Compartment. This is not malfunction. |
| | | Sound like something is caught (clacking) Sound like roaring (honking) Sound caused immediately after closing the door (booming) | | These sounds are caused when the electric parts to control the refrigerator temperature operates. This is not malfunction. |
| Sounds caused by the Automatic ice maker (zooming) (rattling) (clunking) | | | These sounds are made when ice is separated from the ice tray of the auto ice maker or water is supplied to the ice tray. This is not malfunction. To stop the sound, touch the  button to change it to "Off". (→ Pg.57) | |
| Sound occurs sometimes (clacking) | | | This sound is caused when the refrigerator starts the operation to cool. | |
| Door is not in a horizontal state | Door is not in a horizontal state. | Is the installation site level? | This does not affect the refrigerator performance. Adjust the refrigerator adjustable mount to keep it level if you want to correct it. (→ Pg.48) | |
| | | Does the soft floor material sink in around the legs due to the weight of stored items? | Lay a firm board which has more than 1cm thickness on the floor if the refrigerator itself inclines. | |
| | More force is required to open the door immediately after closing the door. | Is a door left open for a long time? | It is because the air that entered the Refrigerator Compartment is rapidly cooled and the pressure in the Refrigerator Compartment temporarily lowers. Do not leave the door open for a long time. Open and close it diligently. | |
| Refrigerator becomes hot | The side of the refrigerator becomes hot. Hot air comes from the bottom of the refrigerator. | _____ | Hot air may come from the bottom of the refrigerator to exhaust the heat generated when the cooling device operates. The temperature may rise to 50 – 60 °C immediately after installation or during summer. It does not pose safety or performance problems, but avoid touching it. | |
| There is something strange with the Vacuum Compartment | Hissing sound does not occur when opening.  | Is the setting of the Vacuum Compartment to "Off" (Non-vacuum)? | Change the setting to "-1°C (Subzero)" or "+1°C (Chiller)". (→ Pg.55) | |
| | | Is the handle pulled up? | Hold down the handle to lock. | |
| | | Is the handle held down to the end and locked? | The vacuum function will not work unless it is locked. Press the handle until it stops to lock it. | |
| | | Is the Vacuum Compartment Gasket removed? | Install the Vacuum Compartment Gasket. (→ Pg.66) | |
| | | Is a food package or a hair caught in the vacuum compartment gasket and the support?  | Remove any packaging material of foods or other things which are caught in. If something adheres to the gasket, the vacuum state cannot be maintained. Clean the vacuum compartment gasket if it is dirty. (→ Pg.66) | |
| | | Does the liquid from food cause the gasket fin to adhere to the gasket?  | | |
| | | Was the door of the Vacuum Compartment or the Refrigerator Compartment just opened / closed? | It takes about three to four minutes for the Vacuum Case to be vacuumed after the vacuum pump starts to operate. Wait for more than four minutes after opening or closing. | |

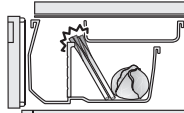
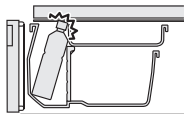
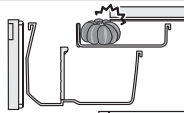
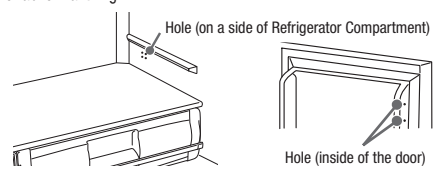

| | When this happens | Check Item | Action and Reasons |
|--|--|---|---|
| There is something strange with the Vacuum Compartment | It is not clear whether the Vacuum Compartment has been vacuumized. | Do you hear a sound when opening the Vacuum Compartment? | The Vacuum Compartment has been vacuumized properly if a vacuum releasing sound (hissing sound) is heard when opening it. |
| | The handle cannot be locked. | Is there any food etc. caught in the inner part of the Vacuum Compartment Case or the vacuum compartment gasket? | Remove any food if it is caught in. |
| | | Is the Vacuum Case set in place? | Mount the Vacuum Case as shown in "How to attach the Vacuum Case". (→ Pg.70) |
| | Booming sound and vibration occur around the Vacuum Compartment. | | This sound is caused when the vacuum pump operates. You can stop the vacuum pump operation when you want to stop the sound (ex: night time). Change the setting of the Vacuum Compartment to "Off" (Non-vacuum). (→ Pg.55) |
| | | Is something caught in the Vacuum Case or the gasket of the Vacuum Compartment dirty? Do you push down the handle until it stops to lock it? | A sound may be heard or vibration may be felt more frequently. Remove any packaging material of foods or other things which are caught in. Clean the vacuum compartment gasket if it is dirty. (→ Pg.67) Push down the handle until it stops to lock it. |
| | Dew, frost or ice is formed inside the Vacuum Compartment or around the Vacuum Case. | Did you place food containing a lot of water?  Dew and/or frost | The moisture from the juicy food may cause dew condensation and/or frost adhering inside the compartment because the Vacuum Compartment is sealed. It is recommended to wrap the juicy food with plastic film, etc. Wipe dew and /or frost off with a soft cloth wet by lukewarm water. |
| The surface of stored vegetables is dented or gets discolored. | Is the vegetable sensitive to low temperature such as eggplant and cucumber? | Move them to the Vegetable Compartment. (→ Pg.55) | |
| Food in the Vacuum Compartment freezes. | Is the Vacuum Compartment set to "-1°C (Subzero)" or "Off" (Non-vacuum)? | Set the "+1°C (Chiller)". (→ Pg.55) | |
| It smells strange | Plastic smells | | This smell occurs because a lot of plastic parts are used in the refrigerator, but the smell decreases gradually while cooling. This is not malfunction. |
| | Ice smells | Do the water supply container and/or water filter become dirty? Or does ice become old? | Wash them regularly to prevent "slime" and/or "fur". (→ Pg.69) |
| | | | Chlorine may strongly smell because chlorine in tap water is condensed. |
| It smells in the refrigerator | Is any food which strongly smells stored without any wrapping? | The deodorizing function cannot completely remove all smells. Seal that kind of food with plastic film etc. | |
| Auto Refrigerator Door | Noise is loud. There is an abnormal noise. | Hitting sound (thumping sound) | This is the operating sound of the Auto Refrigerator Door. This is not malfunction. |
| | | Buzzing sound (whir) | This is the operating sound of the Auto Refrigerator Door. This is not malfunction. |
| | | The operation sound of the Auto Door differs depending on doors (left or right). | This may vary depending on installation conditions of the refrigerator or the volume of foods stored in the door pocket. This is not malfunction. |
| | Auto Door won't open even if touching the Open Button. | Is the Auto Door light not lit? Turn on the light. | Turn on the Auto Door indicator lamp. |
| | | Is the Ice Compartment or the Upper Freezer opened? | Close the slide door and then touch the Open Button of the Auto Refrigerator Door. |
| | The Auto Refrigerator Door does not close. | Is any food or food bag caught on the compartment? | Remove foods and others that are caught in. |
| | | Did a power failure occur or did the compartment knock against any obstacle during electrical operation? | Auto Refrigerator Door stops on the way, so push in the door with hand. |
| Auto Refrigerator Door does not open widely. | Do stored beverages or foods make contact with the wall in the Refrigerator Compartment? | Remove beverages or foods that make contact with the wall. | |
| | Is the installation site level? | Opening angle of the Auto Refrigerator Door may vary or the door may go back a little after it is opened automatically depending on installation conditions of the refrigerator, but this is not malfunction. | |
| Auto Refrigerator Door moves even if it is locked on the Control Panel. | | Auto Refrigerator Door can not be locked from the Control Panel. In order to stop Auto Refrigerator Door, unlock the Control Panel first, and then touch  button for 3 seconds or more until it beeps twice. (→Pg.50, 63) | |
| Auto Drawer | Noise is loud. There is an abnormal noise. | Hitting sound (thumping sound) | This is the operating sound of the Auto Drawer. This is not malfunction. |
| | | Buzzing sound (whirring, grunt) | This is the operating sound of the Auto Drawer. This is not malfunction. |
| | | Operation sound of the Vegetable Compartment is louder than that of the Lower Freezer. | Operation sound of the "vegetable compartment" is louder than the "lower freezer". The operation sound depends on the amount of food stored. This is not malfunction. |
| | The compartment does not open even if the electrical drawer switch is pressed. | Is the Auto Door light not lit? Turn on the light. | Turn on the Auto Door indicator lamp. |
| | | Is either one of the lower freezer or the vegetable compartment open? | Close the open electrical drawer compartment and then press drawer switch for the compartment you want to open. |
| | The Auto Drawer does not open/close. | Is any food, food bag or plastic wrap, etc. caught on the compartment? | Remove foods and others that are caught in. |
| Did a power failure occur or did the compartment knock against any obstacle during electrical operation? | | The door does not open/close smoothly because the electrical drawer function is stopped before the operation completes. Manually push in the door with strength. Otherwise, unplug the power plug with the door drawn, and connect it after 10 seconds. | |
| Is the food caught between the Upper Case and the Moisture Cover?  | | Remove it, if any. Do not close the door with force while the food is in contact with the Moisture Cover. | |
| The Auto Drawer does not open much. | | The Auto Drawer is pulled out by approx. 15 cm or more. The length may vary depending on installation conditions of the refrigerator, or the Auto Drawer may go back a little after the door is opened automatically. This is not malfunction. | |
| Auto Drawer moves even if it is locked on the panel for operation. | | Auto Drawer can not be locked from the panel for operation. In order to stop Auto Drawer function, unlock it first on the panel for operation, and then touch  button for 3 seconds or more until it beeps. (→Pg.50, 63) | |

TROUBLESHOOTING (CONTINUED)

| | When this happens | Check Item | Action and Reasons | |
|---|--|---|--|--|
| Vegetable Compartment | Dew condensation occurs in the Vegetable Compartment. | Did you place a large amount of vegetable containing much water? | As the Vegetable Compartment is more humid than the other compartments, dew may be found in the case or ceiling of the Vegetable Compartment or on the surface of food, depending on the amount or type of vegetable stored there. This is not abnormal state. To avoid condensation, wrap a vegetable with plastic food wrap before storing it in the Vegetable Compartment. Heavy condensation may cause water to be pooled in the Vegetable Compartment. Wipe it off with a soft cloth. | |
| | | Is the Moisture Unit blocked with food bags or containers? | A blocked Moisture Unit is likely to cause condensation. Move the food bags or containers that block the Moisture Unit to other portions. Wipe off the dew with a soft cloth. | |
| | The Vegetable Compartment door doesn't close / When the Vegetable Compartment door is opened, the upper case doesn't go back to the locking position. | Is any food, etc. caught between the upper case and the lower case? |  | Remove it if any. |
| | | Is a plastic bottle and/or food item in contact with the handle of the Upper Case? |  | Store PET bottle, food, etc. so that they don't come in contact with the locking handle. |
| | | Is any food caught between the Upper Case and Moisture Cover? |  | Remove it, if any. Do not close the door with force while the food is in contact with the Moisture Cover. |
| | Others | You feel electricity a little when touching the main body of the refrigerator. | _____ | The refrigerator may be charged with static electricity, but there is no problem with the safety. |
| Radio and/or television are disturbed by noises. | | _____ | It is caused by the electromagnetic radiation slightly generated from this refrigerator. Install the refrigerator away from the television, radio and interphone. It is recommended to connect the power plug to the power outlet separated from the antenna terminal. | |
| There are thin lines like scratches on the plastic parts. | | _____ | Those lines are caused by the liquid resin flowing when plastic is molded. They are especially conspicuous for the transparent parts, but there is no problem with the strength and they can never lead to any cracks. | |
| There are waving and/or distortions on the door surface, the side and the top surface of the refrigerator. | | _____ | Slight waving and/or distortions are generated in the manufacturing process of the refrigerator. They may be conspicuous according to the position of the light source and/or the brightness etc., which is not malfunction. There is no problem with the performance. | |
| There is a small hole inside the door. | | _____ | This hole is used to escape the air inside when filling the heat insulation material into the door during the production process. It is neither a flaw nor abnormal thing.  * Some products have an adhesive seal to conceal the hole. Please do not peel it off. | |
| The electric supply failed. | | _____ | Reduce the number of times of opening and closing the door and avoid storing food additionally until the electric supply is restored. Please check each setting on the panel for operation after the power comes back on. | |
| The refrigerator is expected not to be used for a long term. | | _____ | Remove all the items in the refrigerator. Unplug the refrigerator to take care of the inside or the automatic ice maker. (→ Pg.66-69) Leave all the doors open to dry the refrigerator for 2 or 3 days. | |
| Remove frost. | | _____ | Any operation to remove frost is not required because this refrigerator remove frost automatically. Thawed water is collected in the evaporating tray and automatically evaporates. | |
| Transporting and moving care. | | _____ | See "Transporting your refrigerator (transport for moving)" (→ Pg.49) | |
| Glass is broken (door glass, glass shelf) | | _____ | Do not touch a broken glass, but contact your dealer for repair soon. | |
| When a fruit fly, etc. enters the refrigerator | | Are there fruit flies around it? | _____ | Keep the environment clean. Put something a fruit fly hates or fruit fly can get trapped in something like that. |
| | Is there any food with strong smell in the refrigerator? | _____ | Cover food with the lid so that fruit flies can't be attracted by the smell. | |
| | Is the door left open for a long time? | _____ | Please close the door as soon as possible. | |

AVAILABLE PARTS

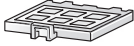
■ If you order any part listed below, specify the model of your refrigerator to a dealer for purchasing genuine parts.

| Subject | Product Name | Model | Product Model | |
|--|--|-----------------------|---------------|---|
| Ice smells ● Water filter may be old and dirty (Replace it about every 3 or 4 years, as a guide) | Water filter for the automatic ice maker | Common for all models | RJK-30 |  |
| Vacuum state can't be maintained ● It may be damaged, deformed or discolored. | Vacuum compartment gasket | R-X730G type | R-WX7400G 311 |  |
| | | R-X670G type | R-XG6700G 311 | |
| | | R-G670G type | R-XG6200G 311 | |
| | | R-G620G type | R-XG6200G 311 | |

有關碳氫化合物的冰箱 / 可容納的食品重量

ABOUT NON-CFC REFRIGERATORS/STORABLE WEIGHT

有關碳氫化合物的冰箱 About non-CFC refrigerators

- 本冰箱所使用冷媒及其他斷熱材料皆無使用氟氯化碳 而是使用碳氫化合物。碳氫化合物不會破壞地球臭氧層、對地球溫室效應的影響非常小、屬於環保物質。
- 碳氫化合物為可燃型物質。冷媒密封於冷媒迴路管中、在一般的使用情況下應該不會發生外洩。但萬一有冷媒管線損壞的情況發生、請遠離火源及避免使用電器用品、將門窗打開以利空氣流通。之後、請立即與經銷商或日立技術中心聯絡。
- Instead of CFCs, hydrocarbons are used in the coolants and insulation materials used in this refrigerator. Hydrocarbons do not damage the ozone layer, and they are environmental-friendly materials, having an exceptionally small affect on global warming.
- Hydrocarbons are flammable. The coolants are sealed in the coolant circuitry, and with normal operation they will not leak, but should the circuitry be damaged, refrain from using flames or other electrical products, and open windows for ventilation. After that, please contact the dealer or Hitachi customer service centre.

可容納的食品重量 Storable weight

可容納於層架或收納盒內的食物重量如下：

The following table shows the weight of food that can be stored on the shelves and in the cases.

| | 零件名稱 Name of parts | R-X730G 型號 R-X730G type | R-X670G 型號 R-G670G 型號 R-X670G type R-G670G type | R-G620G 型號 R-G620G type |
|------------------------------------|---|---|--|----------------------------|
| 冷藏室 Refrigerator compartment | 可調式層架上段 Height adjustable upper shelf | 23.0kg | 21.0kg | 19.5kg |
| | 可調式層架中段 Height adjustable middle shelf | 23.0kg | 21.0kg | 19.5kg |
| | 可調式層架下段, 固定層架 Height adjustable lower shelf, Fixed shelf | 23.0kg | 21.0kg | 18.5kg |
| | 真空冰溫室上方的層架 Upper shelf of the vacuum compartment | 12.0kg | 11.0kg | 10.0kg |
| | 真空冰溫室盒 Vacuum compartment case | 5.5kg | 5.0kg | 4.5kg |
| | 冰箱門置物架 (右側) 合計 Total for the right door pockets | 26.0kg | 26.0kg | 20.0kg |
| | 冰箱門置物架 (左側) 合計 Total for the left door pockets | 14.5kg | 11.0kg | 11.0kg |
| 製冰室 Ice compartment | 儲冰盒 Ice case | 請勿存放不是本自動製冰機製成的冰塊。 → 19頁 Do not store any ice cubes other than the ones made by the automatic ice maker. → Pg.57 | | |
| | 小物品收納空間 Small Article Case | 1.0kg | — | — |
| 上層冷凍室 Upper freezer | 上層冷凍盒 Upper Freezer case | 9.0kg | 9.0kg | 8.0kg |
| 下層冷凍室 Lower freezer | 上層滑動盒 Slimline slide case | 6.0kg | 5.5kg | 5.3kg |
| | 中層滑動盒 Slide case | 8.0kg | 7.0kg | 6.5kg |
| | 下層冷凍盒 Lower freezer case | 19.0kg | 17.0kg | 15.5kg |
| 蔬果保鮮室 Vegetable compartment | 上層滑動盒 Upper Case | 8.5kg | 7.5kg | 7.0kg |
| | 下層置物盒 Lower Case | 24.0kg | 22.0kg | 18.0kg |

關於廢棄之重要警告 Severe warning signs for Disposal

隔熱材料中含有環戊烷 (Cyclopentane)。

當要處理隔熱材料中之氣體時，必須依照特殊的廢棄處理程序。

要廢棄本產品時，為了不會對環境造成不良影響，請詢問當地的相關機關。

Cyclopentane is used in the insulation material.

The gases in insulation material require a special disposal procedure.

Please contact your local authorities in regard to the environmentally safe disposal of this product.

AFTER-SALES SERVICE

關於售後服務

Please contact the following Hitachi Service Centre if power cord is damaged or service is required. If some malfunction occurs during operation, unplug the power plug immediately and contact the service centre to have the refrigerator repaired.

電源線受損或需要維修時，請直接洽詢下列日立服務中心。

使用中出現異常現象時，請立即拔掉電源插頭以及聯絡售後服務中心以進行修理。

- Hong Kong
Hitachi (Hong Kong) Ltd.
18/F., Ever Gain Centre, 28 On Muk Street, Shatin,
N.T., Hong Kong, China
Tel : +852-2753-5386
Fax : +852-2753-0993
- Singapore
Hitachi Home Electronics Asia (S) Pte. Ltd.
438A Alexandra Road, #01-01/02/03,
Alexandra Technopark, Singapore 119967
Tel : +65-6536-2520
Fax : +65-6536-2521
- Indonesia
PT. Hitachi Modern Sales Indonesia.
Rich Palace Shop House Blok D1 & D2
Jl. Meruya Ilir Raya No. 36 - 40
Jakarta 11620, Indonesia
Tel : +62-21-58910088
Fax : +62-21-58910099
- 香港
香港日立有限公司
中國 香港 新界 沙田 安睦街 28 號 永得利中心 18 樓
Tel : +852-2753-5386
Fax : +852-2753-0993
- Malaysia
Hitachi Sales (Malaysia) Sdn. Bhd.
Lot 12, Jalan Kemajuan, Bangi Industrial Estate,
43650 Bandar Baru Bangi,
Selangor Darul Ehsan, Malaysia
Tel : +60-3-8926-4168
Fax : +60-3-8926-3013
- India
Hitachi Home & Life Solutions (India) Ltd.
9th Floor, Abhijeet, Mithakhali Six Roads
Navrangpura, Ahmedabad - 380006
Tel : +91-079-3532-4848/+91-079-30414747
E-mail: customercare@hitachi-hli.com
- Australia
Hitachi Australia Pty. Ltd.
Locked Bag 2052, North Ryde, NSW 1670, Australia
Suite 801, Level 8, 123 Epping Road, North Ryde, NSW,
2113, Australia
Tel : +1-800-448-2244

About Non-fluorocarbon refrigerator

- This refrigerator, including refrigerant and the heat insulator, is using hydrocarbon (non-fluorocarbon). The hydrocarbon is a material that does not rip up the ozone and have very little influence on global warming. It is the global environment friendly material).
- R600a refrigerant is flammable. But the refrigerant is being sealed up by the refrigerate circuit, and never leak by usual use. In case of the refrigerate circuit being damaged by any chance, please avoid the use of fire and electric product, open the window and ventilate. Afterwards, please contact Hitachi Service Center.

Severe warning signs for Disposal

Cyclopentane is used as in the insulation. The gases in insulation material require a special disposal procedure. Please contact your local authorities in regard to the environmentally safe disposal of this product.



This symbol mark means that used electrical and electronic products shall not be mixed with general household waste. Do not try to dismantle the system and unit by yourself as this could have harmful effects on your health and the environment. Refrigerators must be treated at a specialized treatment facility for recycling and recovery and shall not be disposed of in the municipal waste stream. Please contact the installer, dealer or local authority for more information.

Hitachi Tokyo Japan

R-X730G 型號 R-X730G Type ©
R-X670G 型號 R-X670G Type
R-G670G 型號 R-G670G Type
R-G620G 型號 R-G620G Type