

Projector
PJ-TX100
User's Manual - Operating Guide

HITACHI
Inspire the Next

ENGLISH

Thank you for purchasing this projector.

⚠WARNING ▶ Before using, read the "User's Manual - Safety Guide" and these manuals to ensure correct usage through understanding. After reading, store them in a safe place for future reference.

About this manual

Various symbols are used in this manual. The meanings of these symbols are described below.

⚠WARNING This symbol indicates information that, if ignored, could possibly result in personal injury or even death due to incorrect handling.

⚠CAUTION This symbol indicates information that, if ignored, could result possibly in personal injury or physical damage due to incorrect handling.

📖 Please refer to the pages written following this symbol.

NOTE • The information in this manual is subject to change without notice.
• The manufacture assumes no responsibility for any errors that may appear in this manual.
• The reproduction, transmission or use of this document or contents is not permitted without express written authority.

Trademark acknowledgment

- VGA and XGA are registered trademarks of the International Business Machines Corporation.
- Apple and Mac are registered trademarks of the Apple Computer, Inc.
- VESA and SVGA are trademarks of the Video Electronics Standard Association.
- Internet Explorer is a trademark of Microsoft Corporation.

All other trademarks are the property of their respective owners.

Contents

About this manual	1	PICTURE Menu	19
Contents	2	BRIGHT, CONTRAST, GAMMA, COLOR TEMP, COLOR, TINT, SHARPNESS, PROGRESSIVE, MY MEMORY	
Projector features	3	Adjustment steps of the CUSTOM GAMMA or the CUSTOM COLOR TEMP . . .	21
Preparations	3	IMAGE Menu	22
About contents of package	3	ASPECT, OVER SCAN, V POSITION, H POSITION, H PHASE, H SIZE, AUTO ADJUST	
Fastening the lens cover	3	INPUT Menu	24
Part names	4	COLOR SPACE, COMPONENT, VIDEO FORMAT, DVI, S-ASPECT, INFORMATION	
Projector	4	SETUP Menu	26
Remote control	5	KEYSTONE, WHISPER, IRIS, MIRROR	
Setting up	6	SCREEN Menu	27
Arrangement	6	LANGUAGE, MENU POSITION, OSD BRIGHT, START UP, My Screen, My Screen Lock, MESSAGE	
Using the lens shift dials	7	How to register your picture as the MyScreen	28
Adjusting the projector's elevator . . .	7	OPTION Menu	29
Connecting your devices	8	AUTO OFF, LAMP TIME, FILTER TIME, SERVICE	
Connecting power supply	10	Maintenance	31
Remote control	10	Lamp	32
Putting batteries	10	Air filter	33
Using the LIGHT button	11	Inside of the projector	34
Using the remote control	11	Caring for the lens	34
Power on/off	12	Caring for the cabinet and remote control . .	34
Turning on the power	12	Troubleshooting	35
Turning off the power	12	Related messages	35
Operating	13	Regarding the indicator lamps	37
Selecting an input signal	13	Phenomena that may easily be mistaken for machine defects	39
Selecting an aspect ratio	13	Warranty and after-service . . .	41
Adjusting the zoom and focus	14	Specifications	41
Using the automatic adjustment feature	14	Technical (English only) (Please see the end of this book, although only in English.)	
Improving the contrast ratio	14		
Selecting a mode of picture type . .	15		
Adjusting a black image	15		
Adjusting the picture	16		
Recalling your adjustment	16		
Multifunctional settings	17		
Using the menu function	17		
EASY Menu	18		
ASPECT, KEYSTONE, MODE, OPTICAL BLACK, BRIGHT, CONTRAST, COLOR, TINT, SHARPNESS, WHISPER, MIRROR, RESET, FILTER TIME, LANGUAGE, Go To Advanced Menu			

Projector features

This projector is used to project various computer signals as well as NTSC/PAL/SECAP video signals onto a screen. Little space is required for installation and large images can easily be realized.

This is the entertainment projector that will turn your room into a high definition theater!

- Super focus ED (Extra-low dispersion) lenses are adopted for the highest possible image quality.
- 720P wide LCD panels realize faithful reproduction of high-definition images.
- Motorized iris control is provided for realizing film-like images with blacker black.
- 1.6x zoom lens and the optical lens shift allow flexible installation and viewing position.

Preparations

About contents of package

Please see the "Contents of package" of the "User's manual - Quick guide". Your projector should come with the items shown there. Contact immediately your dealer if anything is missing.

NOTE • Keep the original packing materials for future reshipment. For moving the projector, be sure to use the original packing material. Use special caution for the lens part.

Fastening the lens cover

To avoid losing, please fasten the lens cover to the projector using the strap.

1. Fix the strap to the strap ring of lens cover.

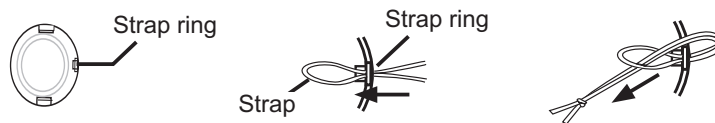

2. Put the strap into the groove on rivet.

3. Push the rivet into the strap hole.

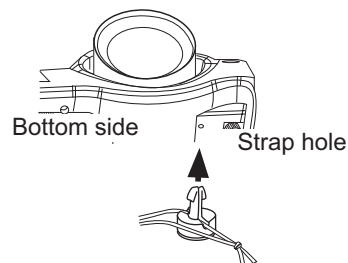

Part names

Part names

Projector

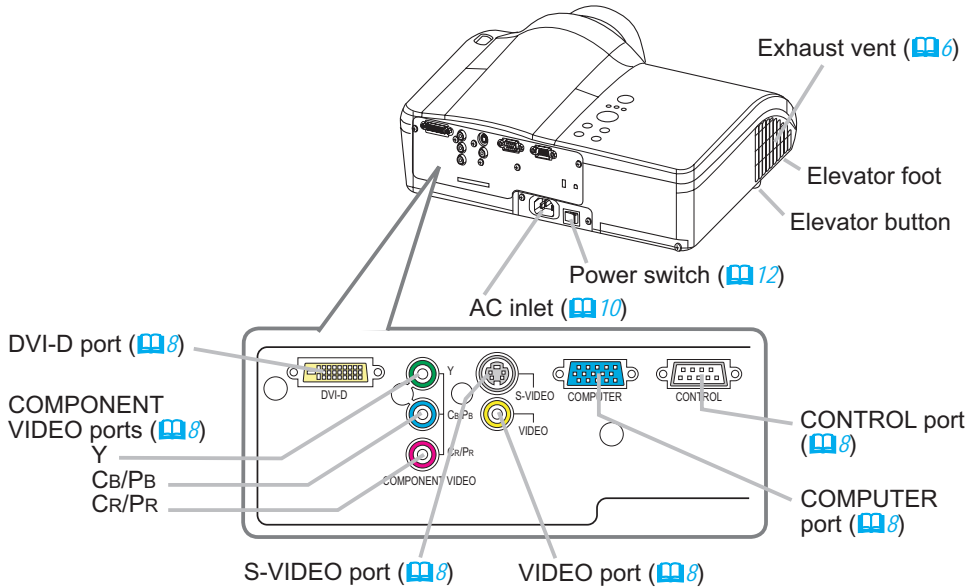
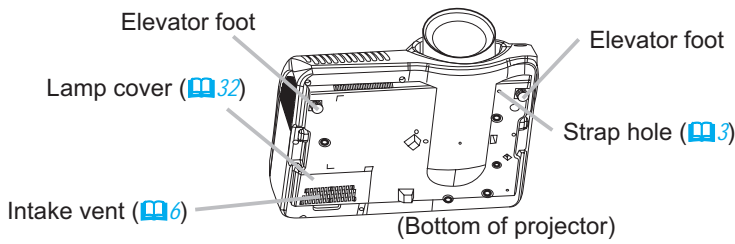
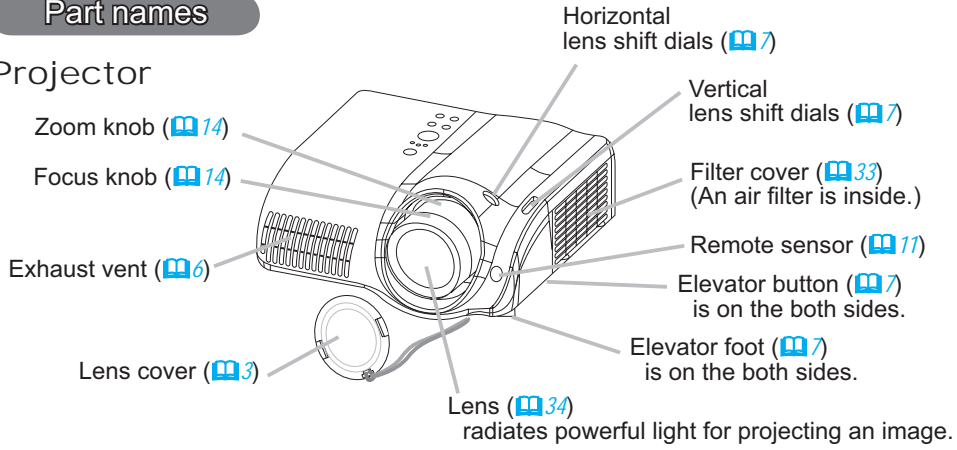

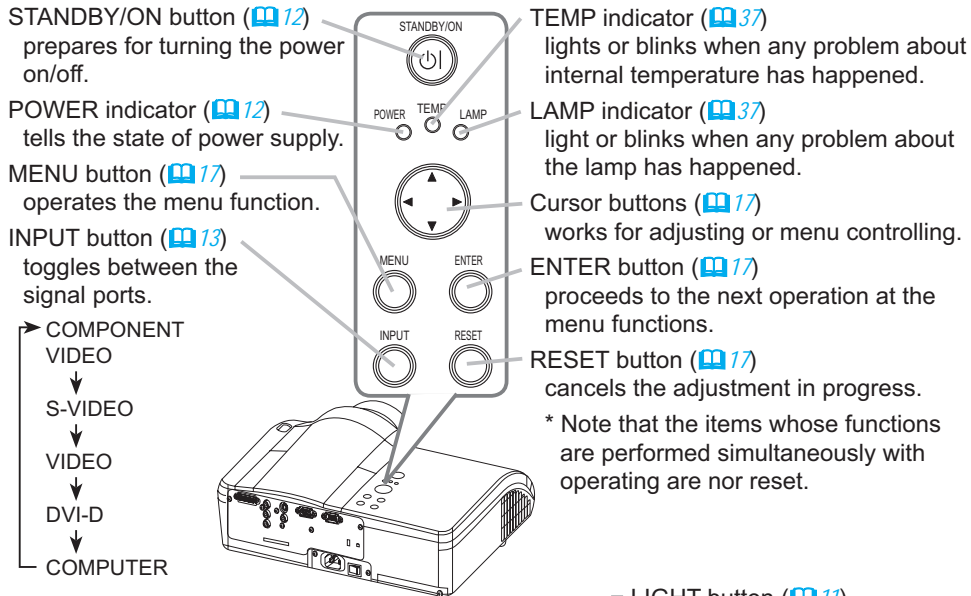

Remote control

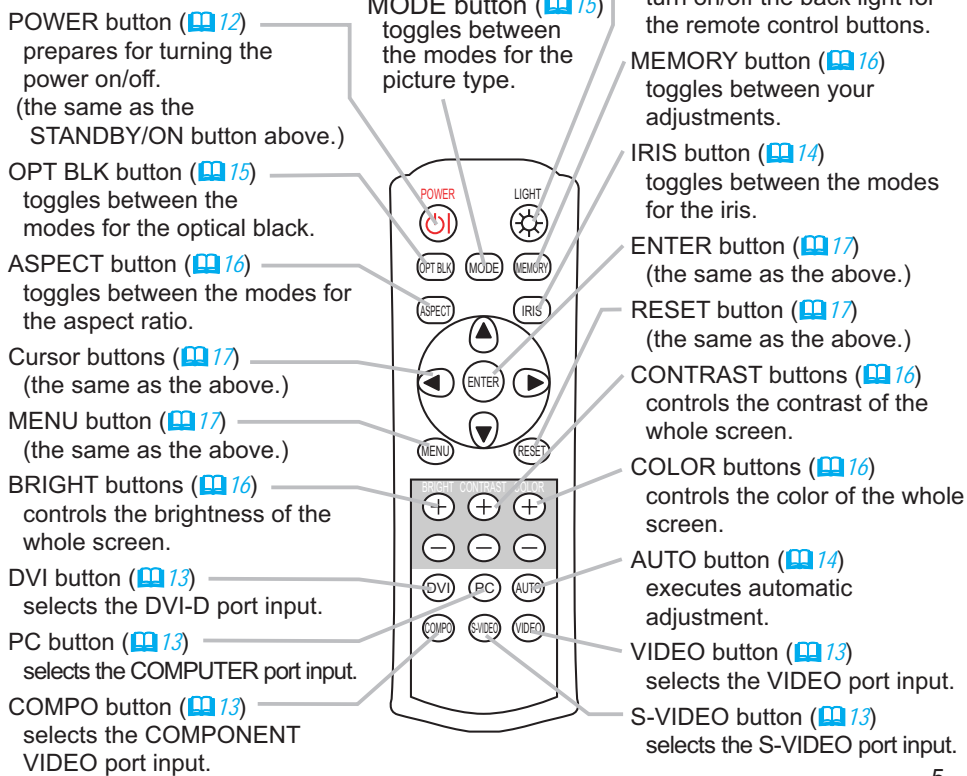

Setting up

Arrangement

⚠WARNING ▶ Install the projector in a suitable environment according to instructions of the "User's Manual - Safety Guide".

⚠CAUTION ▶ In installation, pay attention enough to ventilation. If internal temperature rises, it could cause malfunction. Avoid blocking vents. (about the locations of vents please see [4.](#)) This projector has some intake vents also on the bottom. Put nothing that is sucked or sticks to the bottom of projector.

Refer to the illustrations and tables below to determine the screen size and projection distance.

The values shown in the table are calculated for a full size screen: 1280 x 720

(a) Distance from the projector to the screen ($\pm 10\%$)

(b) The height of the screen ($\pm 10\%$)

At 16:9 screen size

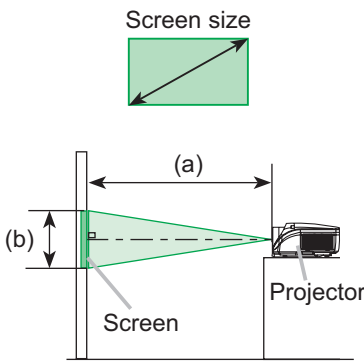

Screen size [inch (m)]	(a)Projection distance [inch (m)]		(b)Screen height [inch (cm)]
	min.	max.	
30 (0.8)	32 (0.8)	52 (1.3)	15 (37)
40 (1.0)	43 (1.1)	70 (1.8)	20 (50)
50 (1.3)	54 (1.4)	89 (2.3)	24 (62)
60 (1.5)	66 (1.7)	107 (2.7)	30 (75)
70 (1.8)	77 (2.0)	125 (3.2)	34 (87)
80 (2.0)	89 (2.2)	143 (3.6)	39 (100)
90 (2.3)	100 (2.5)	161 (4.1)	44 (112)
100 (2.5)	111 (2.8)	179 (4.6)	49 (125)
120 (3.0)	134 (3.4)	215 (5.5)	59 (149)
150 (3.8)	168 (4.3)	270 (6.9)	74 (187)
200 (5.1)	225 (5.7)	360 (9.2)	98 (249)
250 (6.4)	281 (7.1)	451 (11.5)	122 (311)
300 (7.6)	338 (8.6)	541 (13.8)	147 (374)

At 4:3 screen size

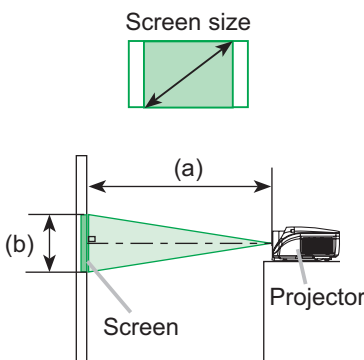

Screen size [inch (m)]	(a)Projection distance [inch (m)]		(b)Screen height [inch (cm)]
	min.	max.	
30 (0.8)	39 (1.0)	65 (1.6)	18 (46)
40 (1.0)	53 (1.4)	87 (2.2)	24 (61)
50 (1.3)	67 (1.7)	109 (2.8)	30 (76)
60 (1.5)	81 (2.1)	131 (3.3)	36 (91)
70 (1.8)	95 (2.4)	153 (3.9)	42 (107)
80 (2.0)	109 (2.8)	175 (4.5)	48 (122)
90 (2.3)	122 (3.1)	198 (5.0)	54 (137)
100 (2.5)	136 (3.5)	220 (5.6)	60 (152)
120 (3.0)	164 (4.2)	264 (6.7)	72 (183)
150 (3.8)	206 (5.2)	330 (8.4)	90 (229)
200 (5.1)	275 (7.0)	441 (11.2)	120 (305)
250 (6.4)	344 (8.7)	552 (14.0)	150 (381)
300 (7.6)	413 (10.5)	663 (16.8)	180 (457)

Using the lens shift dials

⚠CAUTION ▶ Do not put your fingers around the projection lens to prevent them from being caught by the lens and lens ring.

The Lens of this projector can be shifted horizontally and vertically. When you want to adjust the picture position, use the lens shift dials.

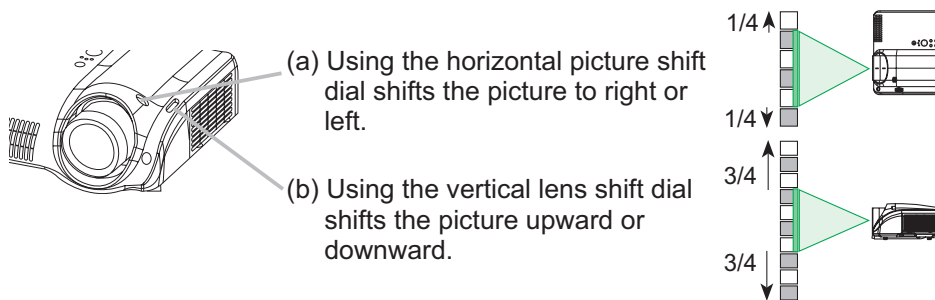

NOTE • Generally, better quality of a picture is available when the lens shift is set to the center known by each click point of the dials.

Adjusting the projector's elevator

⚠WARNING ▶ Do not touch about the lens and ventilation openings during use or immediately after use to prevent a burn.

⚠CAUTION ▶ If you press the elevator button without holding the projector, the projector might crash down, overturn, smash your fingers and possibly result in malfunction. To prevent damaging the projector and injuring yourself, always hold the projector whenever using the elevator buttons to adjust the elevator feet.

▶ Except for inclining by the elevator feet adjustment, place the projector horizontally.

You can use the elevator feet to make adjustments if the surface on which you need to set the projector is uneven or if you otherwise need to adjust the angle of projection. The adjustment range of the elevator feet is 0 to 9 degrees.

1. Press and hold in the elevator buttons.
2. Raise or lower the projector to the desired height and then release the elevator buttons. When you release the elevator buttons, the elevator feet will lock into position.
3. As necessary, you can also finely adjust the height of the projector by twisting the elevator feet by hand.

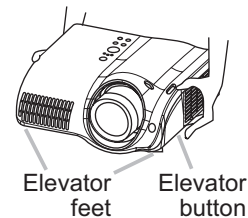

Connecting your devices

⚠WARNING ▶ Incorrect connecting could result in fire or electrical shock. Whenever attempting to connect other devices to the projector, please thoroughly read the "User's Manual - Safety Guide", this manual and the manual of each device to be connected.

⚠CAUTION ▶ Turn off all devices prior to connecting them to the projector. Attempting to connect a live device to the projector may generate extremely loud noises or other abnormalities that may result in malfunction and/or damage to the device and/or projector.

▶ Some cables have to be used with care. A too long cable may cause a certain picture degradation. Use the accessory cable or a designated-type cable for the connection. Please consult with your dealer for details. For cables that have a core only at one end, connect the core to the projector.

▶ Make sure that you connect devices to the correct port. Incorrect connection may result in malfunction and/or damage to the device and/or projector. Refer to the section "TECHNICAL" of this manual for the pin assignment of connectors and RS-232C communication data.

NOTE • Whenever attempting to connect a laptop computer to the projector, be sure to activate the laptop's RGB external image output (set the laptop to CRT display or to simultaneous LCD and CRT display). For details on how this is done, please refer to the instruction manual of the corresponding laptop computer.

- Secure the screws on the connectors and tighten.
- Some computers may have multiple display screen modes. Use of some of these modes will not be possible with this projector.
- For some COMPUTER input modes, the optional Mac adapter is necessary.
- When the image resolution is changed on a computer, depending on an input, automatic adjust function may take some time and may not be completed. In this case, you may not be able to see a check box to select "Yes/No" for the new resolution on Windows. Then the resolution will go back to the original. It might be recommended to use other CRT or TFT monitors to change the resolution.

About Plug-and-Play capability

Plug-and-Play is a system composed of the computer, its operating system and peripheral equipment (i.e. display devices). This projector is compatible with VESA DDC 2B. Plug-and-Play can be achieved by connecting this projector to computers that are VESA DDC (display data channel) compatible.

- Please take advantage of this function by connecting the accessory RGB cable to the COMPUTER port (DDC 2B compatible) and/or the optional DVI cable to the DVI-D port (DDC 2B compatible). Plug-and-Play may not work properly if any other type of connection is attempted.
- Please use the standard drivers in your computer as this projector is a Plug-and-Play monitor.

Setting up

ENGLISH

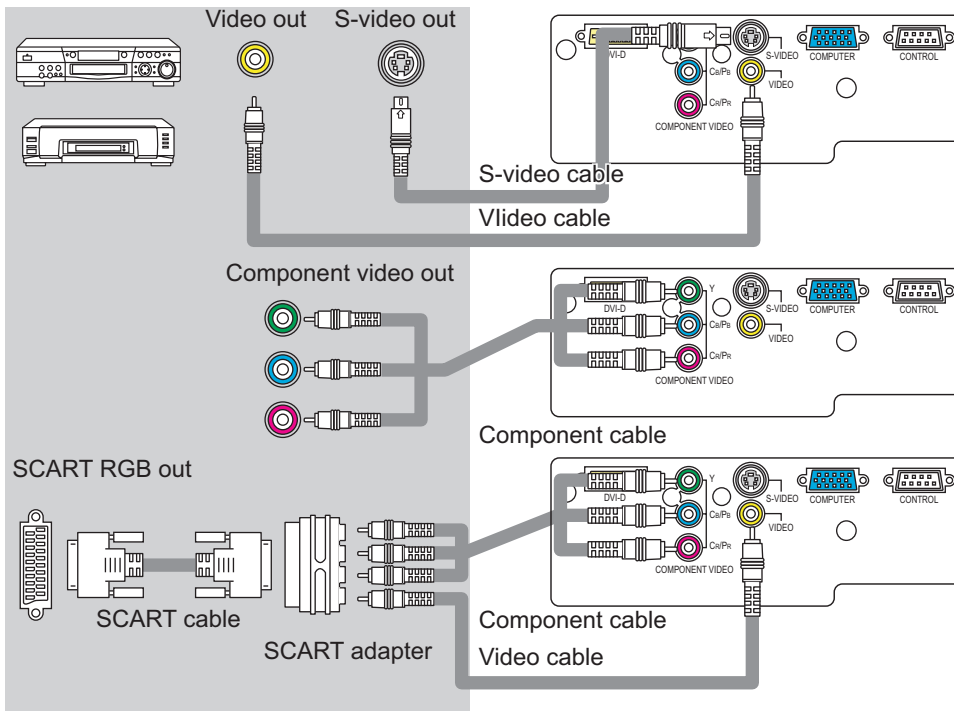
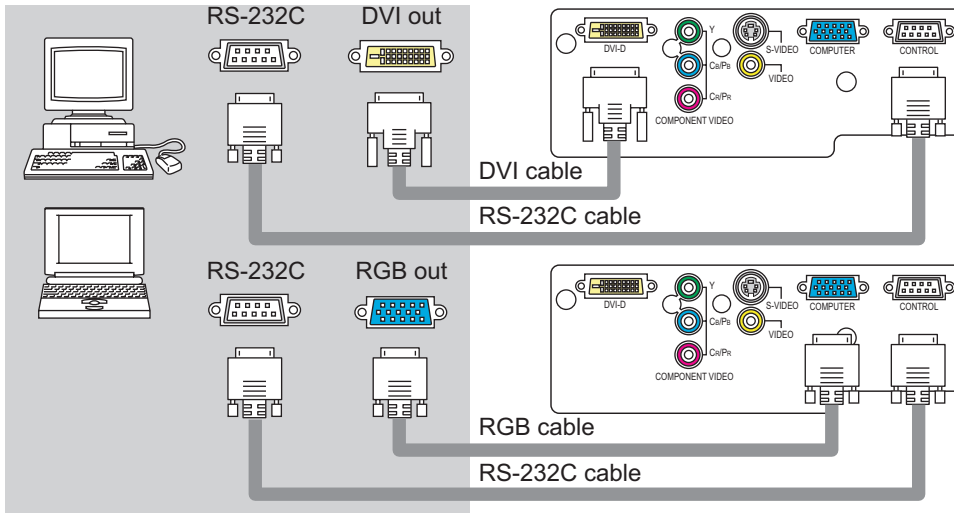

Connecting power supply

⚠WARNING ▶ Please use extra caution when connecting the power cord as incorrect or faulty connections may result in fire and/or electrical shock.

- Only use the power cord that came with the projector. If it is damaged, contact your dealer to newly get correct one.
- Only plug the power cord into an outlet rated for use with the power cord's specified voltage range.
- Never modify the power cord. Never attempt to defeat the ground connection of the three-pronged plug.

1. Connect the connector of the power cord to the AC inlet of the projector.
2. Firmly plug the power cord's plug into the outlet.

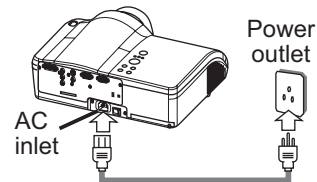

Remote control

Putting batteries

⚠WARNING ▶ Always handle the batteries with care and use them only as directed. Improper use may result in battery explosion, cracking or leakage, which could result in fire, injury and/or pollution of the surrounding environment.

- Be sure to use only the batteries specified. Do not use batteries of different types at the same time. Do not mix a new battery with used one.
- Make sure the plus and minus terminals are correctly aligned when loading a battery.
- Keep a battery away from children and pets.
- Do not recharge, short circuit, solder or disassemble a battery.
- Do not allow a battery in a fire or water. Keep batteries in a dark, cool and dry place.
- If you observe a leakage of a battery, wipe out the flower and then replace a battery. If the flower adheres your body or clothes, rinse well with water immediately.

1. Remove the battery cover.
 - Slide back and remove the battery cover in the direction of the arrow.
2. Insert the batteries.
 - Align and insert the two AAA batteries according to their plus and minus terminals as indicated in the remote control.
3. Close the battery cover.
 - Replace the battery cover in the direction of the arrow and snap it back into place.

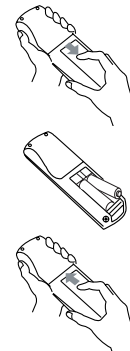

Using the LIGHT button

To illuminate the buttons of the remote control, press the LIGHT button of it.

1. Press the LIGHT button.

If you don't push the LIGHT button again, the lights will turn off in several seconds.

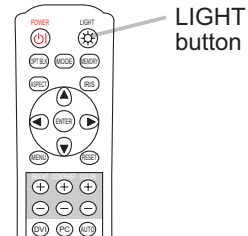

ENGLISH

Using the remote control

⚠CAUTION ▶ Be careful in handling the remote control.

- Do not drop or otherwise expose the remote control to physical impact.
- Do not get the remote control wet or place it on wet objects. Doing so may result in malfunction.
- Remove the batteries from the remote control and store them in a safe place if you won't be using the remote control for an extended period.
- Replace the batteries whenever the remote control starts to malfunction.
- When strong lights, such as direct sunlight or light from an extremely close range (such as from an inverter fluorescent lamp), hit the projector's remote sensor, the remote control may cause to function. Adjust the direction of the projector to keep light from directly hitting the projector's remote sensor.

The remote control works with the projector's remote sensor.

- The range of the remote sensor is 3 meters with a 60-degree range (30 degrees to the left and right of the remote sensor).
- Also a remote signal reflected in the screen etc. may be available. If it is difficult to send a remote signal to the sensor directly, please try.
- Since the remote control uses infrared light to send signals to the projector (Class1 LED), be sure to use the remote control in an area free from obstacles that could block the remote control's output signal to the projector.

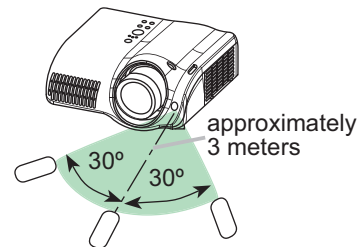

Power on/off

Power on/off

⚠WARNING ▶ When the power is on, a strong light is emitted. Do not look into the lens or vents of the projector.

NOTE • Turn the power on/off in right order. Please power on the projector before the connected devices. Power off the projector after the connected devices.

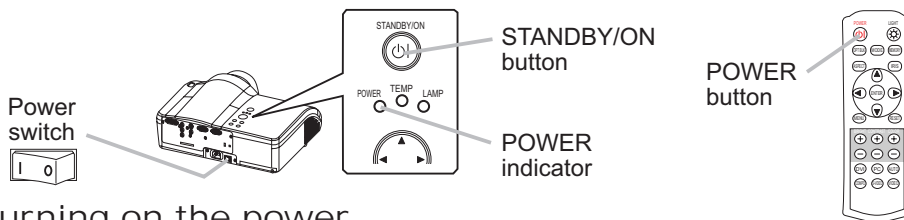

Turning on the power

1. Make sure that the power cord is firmly and correctly connected to the projector and outlet.
2. Remove the lens cover, and set the power switch to the ON position.
The power indicator will light to solid orange. Then wait several seconds because buttons may not function for these several seconds.
3. Press the button STANDBY/ON (projector) or POWER (remote control).
The projector lamp will light up and the POWER indicator will begin blinking green.
When the power is completely on, the indicator will stop blinking light green.

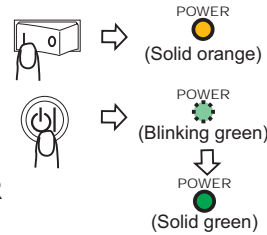

To display the picture, select an input signal according to the section "Selecting an input signal" (13). Then select the aspect ratio (13), adjust the picture position (7), and adjust the zoom and focus (14).

Turning off the power

1. Press the button STANDBY/ON (projector) or POWER (remote control).
The message "Power off?" will appear on the screen for approximately 5 seconds.
2. Press the button STANDBY/ON (projector) or POWER (remote control) again while the message is visible.
The projector lamp will go off, and the POWER indicator will begin blinking orange. Then the POWER indicator will stop blinking and light to solid orange when the lamp cooling is complete.
3. Set the power switch to the OFF position. The POWER indicator will go off.

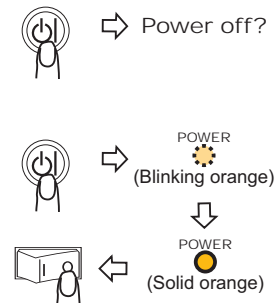

Operating

Selecting an input signal

- Using the projector's button, press the INPUT button.

Each time you press the INPUT button, the projector switches between its input ports. Select the signal you wish to project.

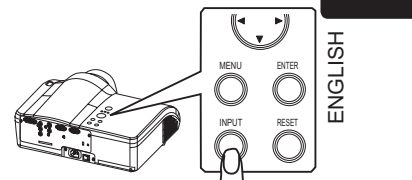

COMPONENT VIDEO → S-VIDEO → VIDEO → DVI-D → COMPUTER



- Using the remote control's button, press the button DVI, PC, COMPO, S-VIDEO or VIDEO according to the input port to choose.

- DVI button ⇒ DVI-D
- PC button ⇒ COMPUTER
- COMPO button ⇒ COMPONENT VIDEO
- S-VIDEO button ⇒ S-VIDEO
- VIDEO button ⇒ VIDEO

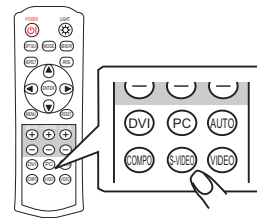

Selecting an aspect ratio

- Press the ASPECT button (remote control) to toggle between the modes for aspect ratio.

The NORMAL mode keeps the original aspect ratio of the signal. At a HDTV signal of 1125i or 750p, only the 16:9 mode can be selected.

- At a DVI-D port's input
4:3 → 16:9 → WIDE → MOVIE1 → MOVIE2 → NORMAL
- At a computer signal (not DVI-D port's input)
4:3 → 16:9 → NORMAL
- At a video signal
4:3 → 16:9 → WIDE → MOVIE1 → MOVIE2
- At no signal
4:3 ↔ 16:9

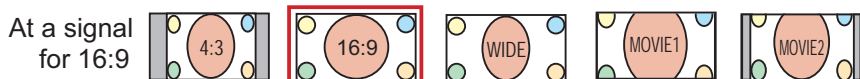
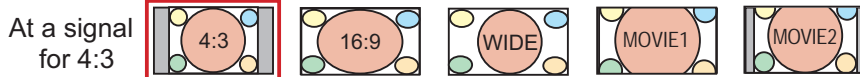
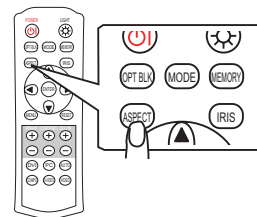

Adjusting the zoom and focus

1. Use the zoom knob to adjust the screen size.
2. Use the focus knob to focus the picture.

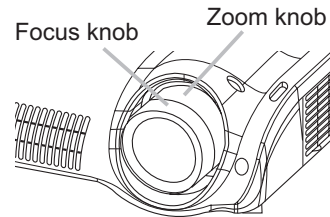

Using the automatic adjustment feature

1. Press the AUTO button (remote control).
 - The automatic adjustment operation requires approximately 10 seconds. Also please note that it may not function correctly with some input.

- At a computer signal

The vertical position, the horizontal position, the clock phase and horizontal size will be automatically adjusted.

Make sure that the application window is set to its maximum size prior to attempting to use this feature. A dark picture may still be incorrectly adjusted. Use a bright picture when adjusting.

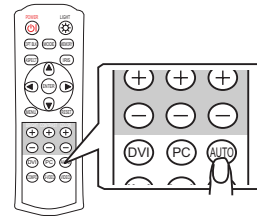

- At a video signal

The video format best suited for the respective input signal will be selected automatically.

This function is available only when the AUTO mode is selected to the item VIDEO FORMAT of the INPUT menu (p.24). For a component video signal, the signal type is identified automatically independently of this function.

Improving the contrast ratio

1. Press the IRIS button (remote control).
 - A dialog will appear on the screen to aid you in adjusting the **iris**.
2. Use the cursor buttons ▲/▼ (remote control/projector) to adjust the iris.
3. Press the IRIS button again to close the dialog and complete this operation.

Even if you don't do anything, the dialog will automatically disappear after about 5 seconds.

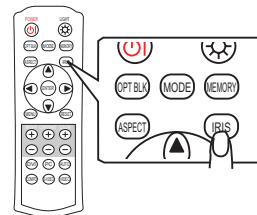

Selecting a mode of picture type

1. Press the MODE button (remote control) to toggle between the modes for picture type.

These arrangements are combinations of a mode of GAMMA (19) and a mode of COLOR TEMP (19). Choose a suitable mode according to the projected source.

NORMAL → CINEMA → MUSIC → SPORTS → DYNAMIC
 ↑

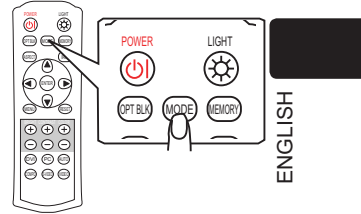

MODE	COLOR TEMP	GAMMA	Description
NORMAL	7500K	#1 DEFAULT	Standard image quality, it can be enjoyed with various sources.
CINEMA	8000K	#2 DEFAULT	Film tone image that is best for cinema picture.
MUSIC	8500K	#3 DEFAULT	The image pursuits DVD source image that is best for music video clip, and the DVD image other than cinema.
SPORTS	9300K	#4 DEFAULT	The image that emphasis on higher contrast that is best for HDTV and sports program.
DYNAMIC	DYNAMIC	#1 DEFAULT	This is the brightest mode of all.

Adjusting a black image

1. Press the OPT BLK button (remote control) to toggle between the modes of OPTICAL BLACK (18).

These arrangements are combinations of a mode of IRIS (26) and a mode of WHISPER (26).

OFF → NATURAL → DEEP BLACK
 ↑

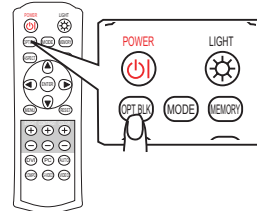

OPTICAL BLACK	IRIS	WHISPER
OFF	10	NORMAL
NATURAL	4	WHISPER
DEEP BLACK	0	WHISPER

Adjusting the picture (brightness, contrast, color)

Brightness and contrast can be adjusted using each (+) and (-) button (remote control). At a video signal, the color can also be adjusted.

1. Press the (+) or (-) button under the item indication to adjust. Use the (+) button to increase the item, or use the (-) button to decrease the item.
A dialog will appear on the screen to aid you in adjusting the item to adjust. You can inactivate the display using the item "MESSAGE" of the SCREEN menu (27).
2. If you don't do anything, the dialog will automatically disappear after about 5 seconds.

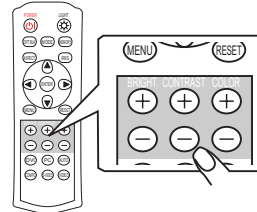

Recalling your adjustment

This projector can memorize 4 settings by the MY MEMORY function of the PICTURE menu (20). Pressing the MEMORY button (remote control) calls the settings and adjusts the current picture. The memory which is not registered is skipped. When there is no memory registered, the picture isn't adjusted.

1. Press the MEMORY button.
Each time you press the MEMORY button, one of memorized settings comes in the order below.

LOAD1 → LOAD2 → LOAD3 → LOAD4

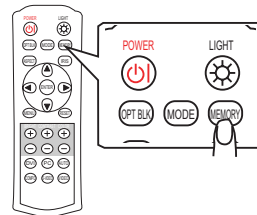

Multifunctional settings

ENGLISH

Using the menu function

This projector has the following menus: PICTURE, IMAGE, INPUT, SETUP, SCREEN, OPTION and EASY MENU. Each of these menus is operated using the same methods. The basic operations of these menus are as follows.

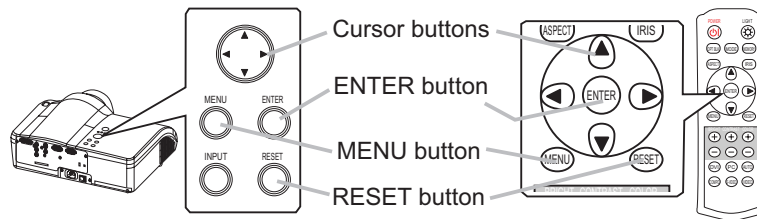

1. Press the MENU button (remote control/projector).
The advanced MENU or EASY MENU will appear. Which menu is displayed is dependent on the last use.
2. Use the cursor buttons ▲/▼ (remote control/projector) to select a menu.
 - At the EASY MENU, if you want it to change to the advanced MENU, select the "Go to Advanced Menu".
 - At the advanced MENU, select a menu of PICTURE, IMAGE, INPUT, SETUP, SCREEN or OPTION. If you want it to change to the EASY MENU, select the EASY MENU.
3. Then press the cursor button ► or the ENTER button (remote control/projector) to progress. The display of the selected menu will active.
4. Use the cursor buttons ▲/▼ to select an item to operate. Then press the cursor button ► or the ENTER button to progress. The operation display of the selected item will appear.
5. Use the cursor buttons ▲/▼ to operate the item.

When you want to reset the operation, press the RESET button (remote control/projector) during the operation. Note that items whose functions are performed simultaneously with operation (ex. LANGUAGE, H PHASE etc.) aren't reset.

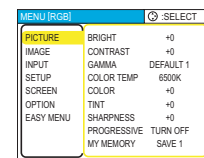

MENU

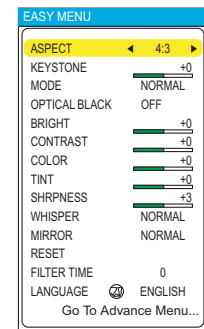

EASY MENU

When you want to return to the previous display, press the cursor button ◀.

6. Press the MENU button again to close the menu and complete this operation. Even if you don't do anything, the dialog will automatically disappear after about 50 seconds.

EASY Menu

With the EASY menu, items shown in the table below can be performed. Perform each operation in accordance with the instructions in the table below.

Select an item using the ▲/▼ buttons, and press the ◀/▶ button to perform each function. :

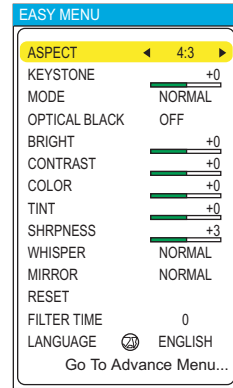

Item	Description
ASPECT	Select the ASPECT menu to toggle the mode of image aspect ratio. Refer to description of "ASPECT" in the "IMAGE" menu. (122)
KEYSTONE	Perform the KEYSTONE adjustment using ◀/▶ buttons.: Refer to description of "KEYSTONE" in the "SETUP" menu. (126)
MODE	Select a picture mode using ◀/▶ button. NORMAL ⇄ CINEMA ⇄ MUSIC ⇄ SPORTS ⇄ DYNAMIC
OPTICAL BLACK	Select a Optical Black mode using ◀/▶ button. OFF ⇄ NATURAL ⇄ DEEP BLACK
BRIGHT	Refer to description of "BRIGHT" in the "PICTURE" menu. (119)
CONTRAST	Refer to description of "CONTRAST" in the "PICTURE" menu. (119)
COLOR	Refer to description of "COLOR" in the "PICTURE" menu. (119)
TINT	Refer to description of "TINT" in the "PICTURE" menu. (119)
SHRPNESS	Refer to description of "SHARPNESS" in the "PICTURE" menu. (120)
WHISPER	Refer to description of "WHISPER" in the "SETUP" menu. (126)
MIRROR	Refer to description of "MIRROR" in the "SETUP" menu. (126)
RESET	EASY MENU reset window will appear. Select "RESET" using "▲" button to reset the all of the items in the "EASY Menu" to the default, except "FILTER TIME" and "LANGUAGE".
FILTER TIME	FILTER TIME reset window will appear. Refer to the "FILTER TIME" in the "OPTION" menu. (129)
LANGUAGE	Select the LANGUAGE to toggle the menu language. Refer to description of "LANGUAGE" in the "SCREEN" menu. (127)
Go To Advanced Menu	Select the "Go To Advanced Menu" to use the PICTURE, the IMAGE, the INPUT, the SETUP, the SCREEN and the OPTION menus.

PICTURE Menu

With the PICTURE menu, the items shown in the table below can be performed. Perform each operation in accordance with the instructions in the table below.

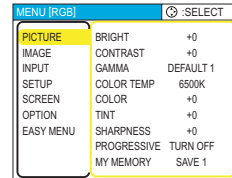

ENGLISH

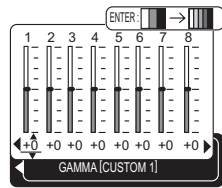
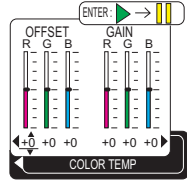
Item	Description
BRIGHT	Adjust the brightness using the ▲/▼ buttons. : Light ⇄ Dark
CONTRAST	Adjust the contrast using the ▲/▼ buttons. : Strong ⇄ Weak
GAMMA	<p>Select a GAMMA mode using the ▲/▼ button. : #1 DEFAULT ⇄ #1 CUSTOM ⇄ #2 DEFAULT ⇄ #2 CUSTOM ⇕ #4 CUSTOM ⇄ #4 DEFAULT ⇄ #3 CUSTOM ⇄ #3 DEFAULT The radio button of the selected will indicate.</p> <p>CUSTOM mode</p> <p>Selecting the CUSTOM and then pressing the ► (or the ENTER) button calls the dialog shown in right. Choose an item using the ◀/▶ buttons, and adjust the level using the ▲/▼ buttons. : <i>memo</i> When you press the ENTER button, the test pattern for checking appears on the screen. (27)</p> 
COLOR TEMP	<p>Select a color temperature using the ▲/▼ buttons. : 9300K ⇄ 8500K ⇄ 8000K ⇄ 7500K ⇄ 6500K ⇄ DYNAMIC ⇄ CUSTOM</p> <p>Selecting CUSTOM and pressing the ► button make the adjustment enabled.</p> <p>CUSTOM mode</p> <p>Select a color item of OFFSET or GAIN using the ◀/▶ buttons, and adjust the level using the ▲/▼ buttons. : <i>memo</i> When you press the ENTER button, the test pattern for checking appears on the screen. (27)</p> 
COLOR	<p>Adjust the whole color using the ▲/▼ buttons. : Strong ⇄ Weak</p> <p><i>memo</i> This item can be selected only at a video signal. <i>memo</i> This function doesn't work with some input signal formats.</p>
TINT	<p>Adjust the tint using the ▲/▼ buttons. : Green ⇄ Red</p> <p><i>memo</i> This item can be selected only at a video signal.</p>

PICTURE Menu (continued)

Item	Description
SHARPNESS	Adjust the sharpness using the ▲/▼ buttons. : Clear ⇔ Soft
PROGRESSIVE	<p>Select the Progressive Mode: TV ⇔ FILM ⇔ TURN OFF</p> <p>memo This function performs only at an interlaced signal of a VIDEO input, a S-VIDEO input or a COMPONENT VIDEO input of 525i or 625i signal. The FILM mode is adaptable to the 3-2 Pull-Down system to the conversion.</p> <p>memo When the TV or FILM is selected, the screen image will be crisper. But it may cause a certain defect (for example, jagged line) of the picture at a quick moving object. In such a case, please select the TURN OFF, even though the screen image may lose the crisp.</p> <p>memo This function may cause a certain degradation of the picture. In such a case, please select the TURN OFF.</p>
MY MEMORY	<p>Selecting one from the following and then pressing the ► (or the ENTER) button performs each function.</p> <p style="text-align: center;"> → LOAD1 ⇔ LOAD2 ⇔ LOAD3 ⇔ LOAD4 ← → SAVE4 ⇔ SAVE3 ⇔ SAVE2 ⇔ SAVE1 ← </p> <p>This projector has 4 numbered memories for adjustment data. Performing the SAVE1, SAVE2, SAVE3 or SAVE4 puts the current adjustment data on the memory whose number corresponds with the command's number. Performing the LOAD1, LOAD2, LOAD3 or LOAD4 loads the data on the memory whose number corresponds with the command's number, and adjusts the picture automatically depending on the data.</p>

PICTURE Menu (continued)

Adjustment steps of the CUSTOM GAMMA or the CUSTOM COLOR TEMP

Press the ENTER button while the CUSTOM menu of "GAMMA" or "COLOR TEMP" is displayed. And the test pattern appears at the top of the screen as shown in the right.

Each time you press the ENTER button, the pattern changes as below.

- No pattern ⇒ Gray scale(9 steps) ↘
- ↙ Ramp ⇒ Gray scale(15 steps)

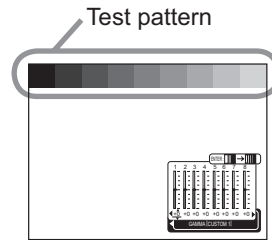

ENGLISH

These patterns help you perceive the effect of your adjustments.

■The CUSTOM GAMMA adjustment

Choose a tone using the ◀/▶ button and adjust the gamma by the ▲/▼ buttons.

This function is useful when you want to change the brightness of the particular tones. Eight of equalizing bars corresponds to eight of tones of test pattern except the darkest in the left end. If you want to adjust the 2nd tone from left end on the test pattern, use the equalizing adjustment bar "1".

memo The darkest tone at the left end of the test pattern cannot be controlled with any of equalizing adjustment bar.

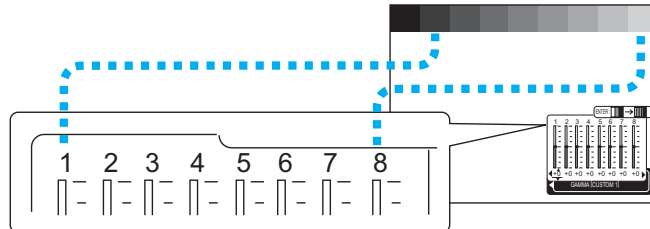

■The CUSTOM GAMMA adjustment

Choose the offset and/or the gain item for each color using the ◀/▶ button and adjust by the ▲/▼ buttons.

OFFSET adjustments change the color intensity on the whole tones of the test pattern.

GAIN adjustments mainly affect color intensity on the brighter tones of the test pattern.

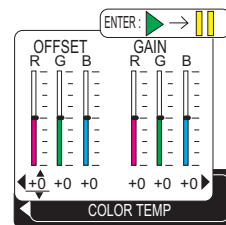

IMAGE Menu

With the IMAGE menu, the items shown in the table below can be performed. Perform each operation in accordance with the instructions in the table below.

MENU (RGB)		SELECT
PICTURE	ASPECT	4:3
IMAGE	OVER SCAN	95
INPUT	V POSITION	25
SETUP	H POSITION	142
SCREEN	H PHASE	16
OPTION	H SIZE	1344
EASY MENU	AUTO ADJUST	

Item	Description
ASPECT	<p>Select an Aspect Ratio using the ▲/▼ buttons:</p> <p>At a COMPUTER input: 4:3 ⇔ 16:9 ⇔ NORMAL</p> <ul style="list-style-type: none"> • The NORMAL keeps the original aspect ratio of the input signal. • At a COMPUTER input, selecting an aspect ratio may display the message“SYNC IS OUT OF RANGE”. In this case, please select one of other aspect ratios. <p>At a DVI-D input: 4:3 ⇔ 16:9 ⇔ WIDE ⇔ MOVIE1 ⇔ MOVIE2 ⇔ NORMAL</p> <p>At a VIDEO input, a S-VIDEO input or a COMPONENT VIDEO input: 4:3 ⇔ 16:9 ⇔ WIDE ⇔ MOVIE-1 ⇔ MOVIE-2</p> <ul style="list-style-type: none"> • At a COMPONENT VIDEO input of 16:9 HD signal of 1125i(1080i)/750p(720p), only 16:9 can be selected. <p>At no input.: 4:3 ⇔ 16:9</p>
OVER SCAN	<p>Adjust the over-scan ratio using the ▲/▼ buttons. : Small ⇔ Large</p> <p><i>memo</i> This item can be selected only at a video signal. <i>memo</i> When this adjustment is too large, certain degradation may appear at the frame area of the picture. In such a case, please adjust small.</p>
V POSITION	<p>Adjust the vertical position using the ▲/▼ buttons. : Up ⇔ Down</p> <p><i>memo</i> This item cannot be selected only at a DVI-D signal.</p>
H POSITION	<p>Adjust the horizontal position using the / buttons. : Left ⇔ Right</p> <p><i>memo</i> This item cannot be selected only at a DVI-D signal.</p>
H PHASE	<p>Adjust the horizontal phase to eliminate flicker using the ▲/▼ buttons. : Right ⇔ Left</p> <p><i>memo</i> This item can be selected only at a RGB signal or a component video signal.</p>

IMAGE Menu (continued)

Item	Description
H SIZE	Adjust the horizontal size using the ▲/▼ buttons. : Large ⇔ Small <i>memo</i> This item can be selected only at a RGB signal. <i>memo</i> When this adjustment is excessive, the picture may not be displayed correctly. In such a case, please reset the adjustment pressing the RESET button during this operation.
AUTO ADJUST	Pressing the ► (or the ENTER) button performs the automatic adjustment. ■At a RGB signal The vertical position (V POSITION), the horizontal position (H POSITION), the clock phase (H PHASE) and the horizontal size (H SIZE) will be automatically adjusted. <i>memo</i> Make sure that the application window is set to its maximum size prior to attempting to use this feature. Dark pictures may still be incorrectly adjusted. Use a bright screen when adjusting. ■At a video signal The signal type mode best suited for the respective input signal will be selected automatically. <i>memo</i> This function is available only when the AUTO is selected to the item "VIDEO FORMAT" of the INPUT menu. For a component video signal, the signal type is identified automatically independently of this function. <i>memo</i> This operation requires approximately 10 seconds, and the message "AUTO IN PROGRESS" is displayed during the operation. <i>memo</i> This operation may not work well at some signals. If the picture becomes unstable (ex. a irregular picture, a color lack), please select the suitable mode to the item "VIDEO FORMAT" of the INPUT menu.

INPUT Menu

With the INPUT menu, the items shown in the table below can be performed. Perform each operation in accordance with the instructions in the table below.

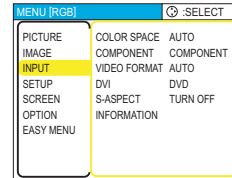

Item	Description
COLOR SPACE	<p>Select a color space mode using the ▲/▼ buttons. : AUTO ⇔ RGB ⇔ SMPTE240 ⇔ REC709 ⇔ REC601 Selecting the AUTO automatically selects the optimum mode. <i>memo</i> This item can not be selected only at a VIDEO or a S-VIDEO signal. <i>memo</i> The AUTO operation may not work well at some signals. In such a case, select the SMPTE240 or the REC709 for a HDTV signal.</p>
COMPONENT	<p>Select a function of COMPONENT port using the ▲/▼ buttons. : COMPONENT ⇔ SCART RGB When the SCART RGB is selected, the COMPONENT port function as a port for a SCART RGB signal input. Please refer to the section "Connecting Your Devices".</p>
VIDEO FORMAT	<p>Select a signal type mode using the ▲/▼ buttons. : AUTO ⇔ NTSC ⇔ PAL ⇔ SECAM ⇔ NTSC4.43 ⇔ M-PAL ⇔ N-PAL Selecting the AUTO automatically selects the optimum mode. <i>memo</i> This item is performs only at a video signal from the VIDEO port or the S- VIDEO port. For a component video signal, the signal type is identified automatically independently of this function. <i>memo</i> The AUTO operation may not work well at some signals. If the picture becomes unstable (ex. a irregular picture, a color lack), please select the mode depending on the input signal.</p>
DVI	<p>Select a signal source of the DVI-D port sing the ▲/▼ buttons. : DVD ⇔ COMPUTER <i>memo</i> If unsuitable setting is chosen, brightest or darkest tones may not be displayed correctly. <i>memo</i> When you watch the DVD, always choose the "DVD" inspite of the signal source, the computer or the DVD player.</p>
S-ASPECT	<p>Select the TURN ON or the TURN OFF using the ▲/▼ buttons. : TURN ON ⇔ TURN OFF When the TURN ON is selected, an S2-video signal can be identified and the optimum aspect ratio is automatically selected. <i>memo</i> This item is performs only at a S-VIDEO signal. <i>memo</i> When the ASPECT button is used or the item "ASPECT" of the IMAGE menu is operated, the TURN OFF will be automatically selected to this item.</p>

INPUT Menu (continued)

Item	Description
<p>INFORMATION</p>	<p>Pressing the ► (or the ENTER) button displays the INPUT INFORMATION menu. The INPUT INFORMATION menu shows the information about the current signal input as illustrated below.</p> <div style="display: flex; justify-content: space-around; align-items: center;"> <div style="border: 1px solid black; padding: 5px; text-align: center;"> <small>◀ INPUT-INFORMATION</small> RGB 1024x768 @60.0 FRAME LOCK </div> <div style="border: 1px solid black; padding: 5px; text-align: center;"> <small>◀ INPUT-INFORMATION</small> S-VIDEO SECAM AUTO </div> <div style="border: 1px solid black; padding: 5px; text-align: center;"> <small>◀ INPUT-INFORMATION</small> COMPONENT 576i @50 SCART RGB </div> </div> <p>memo The “FRAME LOCK” message means the frame lock function is working. This function automatically works when a RGB signal with vertical frequency of 50 to 60 Hz is input, and it displays a moving picture more smoothly.</p> <p>memo The “SCART RGB” message means the COMPONENT port is working as a SCART RGB port. Please refer to the item “COMPONENT” in this table.</p>



ENGLISH

SETUP Menu

With the SETUP menu, items shown in the table below can be performed. Perform each operation in accordance with the instructions in the table below.

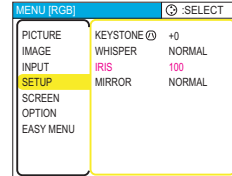

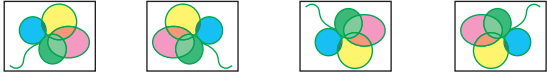
Item	Description
KEYSTONE	<p>Adjust the Keystone (Vertical) Distortion: Upper in the data ⇔ Lower in the data</p> <p>memo The adjustable range of this function will vary with the type of input signal. At some signals, this function may not work well.</p> <p>memo When the V:INVERT or the H&V:INVERT is selected under the MIRROR item, if the projector screen is inclined or if the projector is angled downward, this function may not work correctly.</p> <p>memo When the WIDE is selected under the ASPECT item of the IMAGE menu, this adjustment is ignored.</p> <p>memo When the zoom adjustment is set to the TELE side, this correction may be excessive. This function should be used with zoom set to WIDE whenever possible.</p>
WHISPER	<p>Select the NORMAL or the WHISPER using the ▲/▼ buttons. : NORMAL ⇔ WHISPER</p> <p>When the WHISPER is selected, acoustic noise and screen brightness are reduced.</p>
IRIS	<p>Adjust the iris using the ▲/▼ buttons. : Bright ⇔ Dark</p>
MIRROR	<p>Select a mirror status using the ▲/▼ buttons. : NORMAL ⇔ H:INVERT ⇔ V:INVERT ⇔ H&V:INVERT</p> 

SCREEN Menu

With the SCREEN menu, the items shown in the table below can be performed. Perform each operation in accordance with the instructions in the table below.

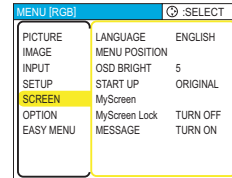

ENGLISH

Item	Description
LANGUAGE	Select a menu language using the ▲/▼ buttons. : ENGLISH ⇄ FRANÇAIS ⇄ DEUTSCH ⇄ ESPAÑOL ⇄ ITALIANO NORSK ⇄ NEDERLANDS ⇄ PORTUGUÊS ⇄ 日本語 ⇄ 中文 한글 ⇄ SVENSKA ⇄ РУССКИЙ ⇄ SUOMI ⇄ POLSKI
MENU POSITION	Adjust the menu position using the ▲/▼/◀/▶ buttons.: Up ↑ Left ⇄ ⇄ Right ↓ Down To quit the operation, press the “MENU” button or keep no operation for 50 seconds.
OSD BRIGHT	Select a brightness level of the OSD on the screen using the ▲/▼ buttons. : BRIGHT ⇄ DARK
START UP	Select a type of the START UP screen using the ▲/▼ buttons. : MyScreen ⇄ ORIGINAL ⇄ TURN OFF The START UP screen is the screen, which is displayed by detecting no signal or an unsuitable signal. The MyScreen is the screen you can register a desired screen, and the ORIGINAL is the existing standard screen. When the TURN OFF is selected, the BLUE is used. <i>memo</i> The MyScreen and the ORIGINAL Screen will each change to a non-patterned (plain) black color screen several minutes after being displayed. <i>memo</i> About the MyScreen, please refer to the item “MyScreen” in this table.
My Screen	Pressing the ▶ (or the ENTER) button starts the MyScreen registration. Please see the flow chart on the following page.
My Screen Lock	Select the TURN ON or the TURN OFF using the ▲/▼ buttons. : TURN ON ⇄ TURN OFF The TURN ON disables the operation of the item “MyScreen” of this SCREEN menu.

SCREEN Menu (continued)

Item	Description
MESSAGE	Select the TURN ON or the TURN OFF using the ▲/▼ buttons. : TURN ON ⇔ TURN OFF When the TURN ON is selected, the following message function works. The message of the "AUTO IN PROGRESS" for the auto adjustment. The message of the "NO INPUT IS DETECTED" The message of the "SYNC IS OUT OF RANGE" The message of the "Detecting ..." The indication of the input signal by input change. The indication of the aspect ratio by changing the aspect ratio. The indication of "IRIS", "BRIGHT", "CONTRAST", "COLOR" by adjusting them.

How to register your picture as the MyScreen

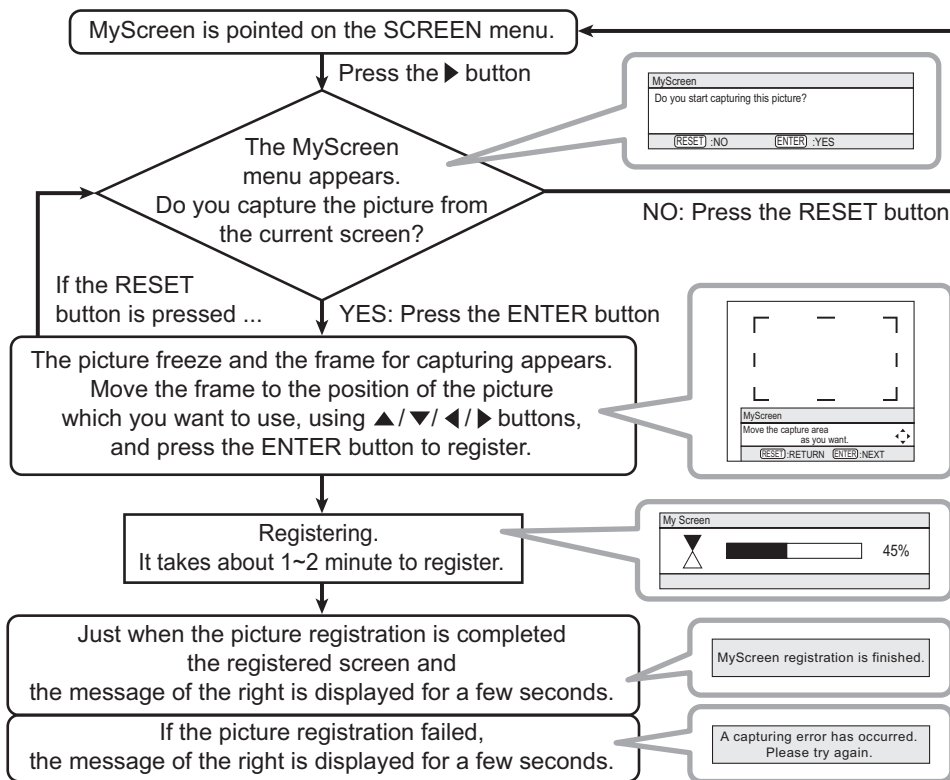

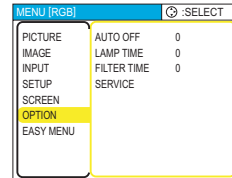

OPTION Menu

With the OPTION menu, items shown in the table below can be performed. Perform each operation in accordance with the instructions in the table below.



ENGLISH

Item	Description
AUTO OFF	<p>Set the time using the ▲/▼ buttons. : Long (max. 99 minutes) ⇔ Short (min. 0 minute = DISABLE)</p> <p>ex.  </p> <p>When the time is set to 1 to 99, the projector lamp will go off and the power indicator begins blinking when the passed time with a proper signal (without no-signal and an unsuitable signal) reaches at the set time. Please refer to the section "Turning Off The Power".</p>
LAMP TIME	<p>Pressing the RESET button for about 3 seconds displays the LAMP TIME menu. Select the RESET using ▲ button to reset the timer. : RESET ⇔ CANCEL</p> <p>Selecting the RESET resets the count of the lamp timer to 0. <i>memo</i> Perform this function only when you have replaced the lamp. The lamp timer counts the used time of the current lamp, to display the messages about the lamp. Incorrect performing causes incorrect operation of the messages. <i>memo</i> About replacing the lamp, please refer to the section "Lamp".</p>
FILTER TIME	<p>Pressing the RESET button for about 3 seconds displays the FILTER TIME menu. Select the RESET using ▲ button to reset the timer. : RESET ⇔ CANCEL</p> <p>Selecting the RESET resets the count of the lamp timer to 0. <i>memo</i> Perform this function only when you have cleaned or replaced the air filter. The filter timer counts the used time of the air filter after cleaning or replacement, to display the messages about the air filter. Incorrect performing causes incorrect operation of the messages. <i>memo</i> About caring for the air filter, please refer to the section "Air Filter".</p>

OPTION Menu (continued)

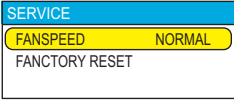
Item	Description
<p>SERVICE</p>	<p>Pressing the ► (or the ENTER) button calls the SERVICE menu.</p> <p>SERVICE Menu Select an item using the ▲/▼ buttons, and press the ► (or the ENTER) button to perform each function. : FANSPEED ⇔ FACTORY RESET</p> 
	<p>FANSPEED</p> <p>Select the fan speed level using the ▲/▼ buttons. : HIGH ⇔ LOW The HIGH ups rotation speeds of fans. Please use this function in using a projector at highlands etc. <i>memo</i> Note that the projector is noisier when the HIGH is selected.</p>
	<p>FACTORY RESET</p> <p>Initialize the Items in all of the menus: Selecting the RESET performs this function. RESET ⇔ CANCEL All the items in all of menu will collectively returned to the factory defaults. Note that the items “Lamp Time”, “Filter Time” and “Language” are not reset.</p>

Maintenance

 **LAMP WARNING**  HIGH VOLTAGE  HIGH TEMPERATURE  HIGH PRESSURE

► The projector uses a high-pressure mercury glass lamp. The lamp can break with a loud bang, or burn out, if jolted or scratched, handled while hot, or worn over time. Note that each lamp has a different lifetime, and some may burst or burn out soon after you start using them. In addition, when the bulb bursts, it is possible for shards of glass to fly into the lamp housing, and for gas containing mercury to escape from the projector's vent holes.

► **About disposal of a lamp** • This product contains a mercury lamp; do not put in trash. Dispose of in accord with environmental laws. For lamp recycling, go to www.lamprecycle.org. (in the US) For product disposal, contact your local government agency or www.eiae.org (in the US) or www.epsc.ca (in Canada). For more information, call your dealer.



- If the lamp should break (it will make a loud bang when it does), unplug the power cord from the outlet, and make sure to request a replacement lamp from your local dealer. Note that shards of glass could damage the projector's internals, or cause injury during handling, so please do not try to clean the projector or replace the lamp yourself.
- If the lamp should break (it will make a loud bang when it does), ventilate the room well, and make sure not to breathe the gas that comes out of the projector vents, or get it in your eyes or mouth.
- Before replacing the lamp, make sure the power switch is off and the power cable is not plugged in, then wait at least 45 minutes for the lamp to cool sufficiently. Handling the lamp while hot can cause burns, as well as damaging the lamp.



- Never unscrew except the appointed (marked by an arrow) screws.
- Do not open the lamp cover while the projector is suspended from above. This is dangerous, since if the lamp's bulb has broken, the shards will fall out when the cover is opened. In addition, working in high places is dangerous, so ask your local dealer to have the lamp replaced even if the bulb is not broken.
- Do not use the projector with the lamp cover removed. At the lamp replacing, make sure that the screws are screwed in firmly. Loose screws could result in damage or injury.



- Use only the lamp of the specified type.
- If the lamp breaks soon after the first time it is used, it is possible that there are electrical problems elsewhere besides the lamp. If this happens, contact your local dealer or a service representative.
- Handle with care: jolting or scratching could cause the lamp bulb to burst during use.
- If the indicators or a message prompts you to replace the lamp (see the section "Related Messages" and "Regarding the indicator Lamps"), replace the lamp as soon as possible. Using the lamp for long periods of time, or past the replacement date, could cause it to burst. Do not use old (used) lamps; this is a cause of breakage.

Lamp

If the indicators or a message prompts you to replace the lamp, replace the lamp as soon as possible.

1. Turn off the projector, and unplug the power cord. Allow the lamp bulb to cool for at least 45 minutes.
2. Contact your dealer to prepare a new lamp. Tell the dealer your lamp type number: **DT00661**. If the projector is mounted on the ceiling, or if the lamp has broken, also ask the dealer to replace the lamp.

In the case of replacement by yourself,

3. After making sure that the projector has cooled adequately, slowly flip over the projector, so that the bottom is facing up.
4. Unscrew the screw (marked by arrow) of the lamp cover, the slide and take the lamp cover up.
5. Unscrew the 2 screws (marked by arrow), and slowly pick up the lamp by the handles.
6. Insert the new lamp, and retighten firmly two screws unscrewed in the previous process to lock it in place.
7. Slide the lamp cover into place, and retighten firmly the screw of the lamp cover unscrewed in the process number 4.
8. Turn on the projector power, and reset the lamp timer.
 - (1) While the projector running, press the MENU button to open the menu.
 - (2) Choose the "OPTION" on the menu using the ▲/▼ button, then press the ► button or ENTER button.
 - (3) Choose the "LAMP TIME" using the ▲/▼ button, then press and hold the RESET button for 3 seconds.
 - (4) Choose the "RESET" using the ▲ button.

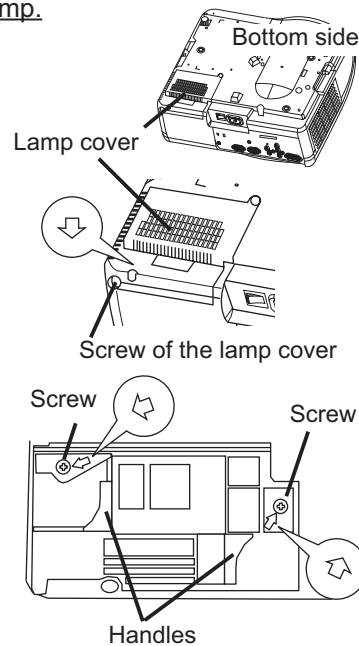

NOTE • When the lamp has been replaced after the message of "THE POWER WILL TURN OFF AFTER 0hr." is displayed, complete the following operation within 10 minutes of switching power on.
 • Incorrectly resetting of the lamp timer (resetting without replacement, or neglect of resetting after replacement) will result in incorrect message functions.

Air filter

⚠WARNING ▶ Before replacing the lamp, make sure the power switch is off and the power cord is not plugged in, then wait at least 45 minutes for the lamp to cool sufficiently.

▶ Use only the air filter of the specified type. Do not use the projector with the air filter and filter cover removed.

⚠CAUTION ▶ If the air filter becomes clogged by dust or the like, internal temperature rises and the power may be automatically turned off for malfunction prevention.

ENGLISH

If the indicators or a message prompts you to clean the air filter, clean the air filter as soon as possible. Please replace the air filter when you replace the lamp, and also when it is damaged or too soiled.

1. Turn off the projector, and unplug the power cord. Allow the lamp bulb to cool for at least 45 minutes.

2. After making sure that the projector has cooled adequately, remove the filter cover and the air filter. Hold its release buttons while pulling up it.

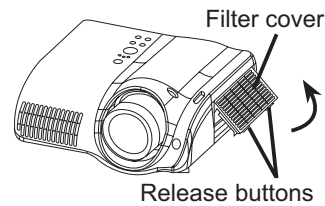

3. Apply a vacuum cleaner to the filter cover and the air filter.

To replace the air filter,

Contact your dealer to prepare a new air filter. Tell the dealer your air filter type number: **NJ09452.**

4. Insert the cleaned air filter or a new air filter, and replace the filter cover.

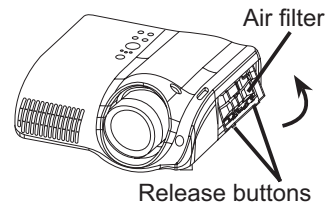

5. Turn on the projector power, and reset the filter timer.

(1) While the projector running, press the MENU button to open the menu.

(2) Choose the "OPTION" on the menu using the ▲/▼ button, then press the ► button or ENTER button.

(3) Choose the "FILTER TIME" using the ▲/▼ button, then press and hold the RESET button for 3 seconds.

(4) Choose the "RESET" using the ▲ button.

NOTE • Incorrectly resetting of the filter timer (resetting without replacement, or neglect of resetting after replacement) will result in incorrect message functions.

Maintenance

- ⚠ **WARNING** ▶ Please carefully read the "User's Manual - Safety Guide".
- ▶ Before caring, make sure the power switch is off and the power cord is not plugged in.
 - ▶ Be cautious of high temperature. Do not touch about the lens and ventilation openings during use or immediately after prevent a burn.
 - ▶ Never try to care for the inside of the unit yourself. Doing so is dangerous.
- ⚠ **CAUTION** ▶ Incorrect care could have adverse influence such as discoloration, peeling paint, etc.
- ▶ Do not use cleaner or chemicals other than those listed below, including benzene and paint thinner.
 - ▶ Do not use aerosols or sprays.
 - ▶ Do not polish or wipe with hard objects.

Inside of the projector

In order to ensure the safe use of your projector, please have it cleaned and inspected by your local dealer about once every 2 years.

Caring for the lens

1. Turn off the projector, and unplug the power cord.
2. Lightly wipe the lens with a commercially available lens-cleaning wipe. Do not touch the lens directly with your hand.

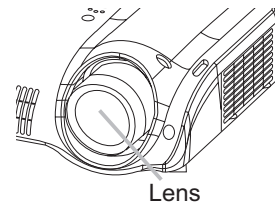

Caring for the cabinet and remote control

1. Turn off the projector, and unplug the power cord.
2. Wipe lightly with gauze or a soft cloth. If soiling is severe, dip soft cloth in water or a neutral cleaner dilute in water, and wipe lightly after wringing well. Then, wipe lightly with a soft, dry cloth.

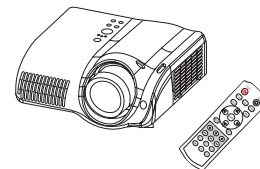

Troubleshooting



ENGLISH

Related messages

When the unit's power is on, messages such as those shown below may be displayed. When any such message is displayed on the screen, please respond as described below. If the same message is displayed after the treatment, or if a message other than the following appears, please contact your dealer or service company.

Although these messages will be automatically disappeared around several minutes, it will be reappeared every time the power is turned on.

Message	Description
<p>☼ CHANGE THE LAMP</p> <p>AFTER REPLACING LAMP, RESET THE LAMP TIMER.</p>	<p>The time the lamp timer has counted is approaching 2000 hours.</p> <p>Preparation of a new lamp, and an early lamp change is recommended. After you have change the lamp, please be sure to reset the lamp timer.</p>
<p>☼ CHANGE THE LAMP</p> <p>AFTER REPLACING LAMP, RESET THE LAMP TIMER.</p> <p>THE POWER WILL TURN OFF AFTER ** hr.</p>	<p>The time the lamp timer has counted is approaching 2000 hours, so a lamp change within ** hours is recommended.</p> <p>When lamp usage reaches 2000 hours, the power will automatically be turned off. Please change the lamp by referring to the section "Lamp". After you have changed the lamp, please be sure to reset the lamp timer.</p>
<p>☼ CHANGE THE LAMP</p> <p>AFTER REPLACING LAMP, RESET THE LAMP TIMER.</p> <p>THE POWER WILL TURN OFF AFTER 0 hr.</p>	<p>As the time the lamp timer has counted has reached 2000 hours, the power will soon be automatically turned off.</p> <p>Please immediately turn the power off, and change the lamp by referring to the section "Lamp". After changing the lamp, please be sure to reset the lamp timer.</p>
<p>NO INPUT IS DETECTED ON ***</p>	<p>There is no input signal.</p> <p>Please confirm the signal input connection, and the status of the signal source.</p>

(This table is continued to the following page.)

NOTE • A lamp has a finite product life. Lamps are characterized by the fact that, after long hours of usage, a lamp will no longer light up, or the lamp will break or burst, etc. This projector is equipped with an automatic shut-down function, such that the power will automatically be turned off when lamp usage time has reached 2000 hours. Please be aware, however, that among lamp types, there are major differences in product lifetimes; a lamp may thus fail to light even prior to the functioning of the automatic shut-down function of this projector.

Related messages (continued)

Message	Description
<p>SYNC IS OUT OF RANGE ON *** [fH] *****kHz [fV] *****Hz</p>	<p>The horizontal or vertical wavelength of the inputted signal is outside of the response parameters of this unit. Please confirm the specs for this unit or the signal source specs.</p>
<p>CHECK THE AIR FLOW</p>	<p>The internal portion temperature is rising. Please turn the power OFF, and allow the unit to cool down at least 20 minutes. After having confirmed the following items, please turn the power ON again.</p> <ul style="list-style-type: none"> • Is there blockage of the air passage aperture? • Is the air filter dirty? • Does the peripheral temperature exceed 35°C?
<p>CLEAN THE AIR FILTER POWER OFF FIRST, THEN CLEAN THE AIR FILTER. AFTER CLEANING THE AIR FILTER, RESET THE FILTER TIMER.</p>	<p>A note of precaution when cleaning the air filter. Please immediately turn the power OFF, and clean or change the air filter by referring to the “Air Filter” section of this manual. After you have cleaned or changed the air filter, please be sure to reset the filter timer. If the same message is displayed after the treatment, please clean the transparent area of filter cover and the dust-detecting window, according to the following.</p>

⚠CAUTION ▶ The transparent area of filter cover and the dust-detecting window should be cleaned for normal operation of the optical dust detecting system. Please pay attention not to remain fiber or fragment of cloth inside the duct.

1. Turn off the projector, and unplug the power cord.
2. After making sure that the projector has cooled adequately, remove the filter cover.
 Hold the release buttons of the filter cover, while pulling up it.
3. Wipe the transparent area of the filter cover by using a swab or a soft cloth.
4. Remove the air filter.
 Hold the release buttons of the air filter, while pulling up it.
5. Wipe the dust-detecting window by using a soft cloth.
6. Replace the air filter and filter cover.

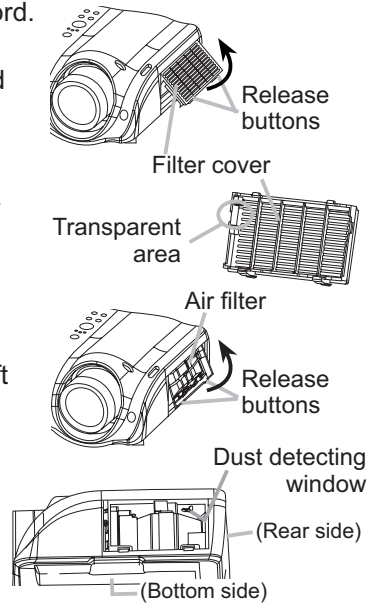

Regarding the indicator lamps

Lighting and flashing of the POWER indicator, the LAMP indicator, and the TEMP indicator have the meanings as described in the table below. Please respond in accordance with the instructions within the table. If the same indication is displayed after the treatment, or if an indication other than the following is displayed, please contact your dealer or service company.

NOTE • When the interior portion has become overheated, for safety purposes, the power source is automatically turned off, and the indicator lamps may also be turned off. In such a case, press the “O” (OFF) side of the main power switch, and wait at least 45 minutes. After the projector has sufficiently cooled down, please make confirmation of the attachment state of the lamp and lamp cover, and then turn the power on again.

POWER indicator	LAMP indicator	TEMP indicator	Description
Lighting In Orange	Turned off	Turned off	The projector is in a standby state. Please refer to the section “Power On/Off”.
<i>Blinking</i> In Green	Turned off	Turned off	The projector is warming up. Please wait.
Lighting In Green	Turned off	Turned off	The projector is in an on state. Ordinary operations may be performed.
<i>Blinking</i> In Orange	Turned off	Turned off	The projector is cooling down. Please wait.
<i>Blinking</i> In Red	(discretionary)	(discretionary)	The projector is cooling down. A certain error has been detected. Please wait until the POWER indicator finishes blink, and then perform the proper response measure using the item descriptions below as reference.
<i>Blinking</i> In Red or Lighting In Red	Lighting In Red	Turned off	The lamp does not light, and there is a possibility that interior portion has become heated. Please turn the power off, and allow the unit to cool down at least 20 minutes. After the projector has sufficiently cooled down, please make confirmation of the following items, and then turn the power on again. • Is there blockage of the air passage aperture? • Is the air filter dirty? • Does the peripheral temperature exceed 35°C? If the same indication is displayed after the treatment, please change the lamp by referring to the section “Lamp”.

Regarding the indicator lamps (continued)

POWER indicator	LAMP indicator	TEMP indicator	Description
Blinking In Red or Lighting In Red	Turned off	Blinking In Red	The cooling fan is not operating. Please turn the power off, and allow the unit to cool down at least 20 minutes. After the projector has sufficiently cooled down, please make confirmation that no foreign matter has become caught in the fan, etc., and then turn the power on again. If the same indication is displayed after the treatment, please contact your dealer or service company.
Blinking In Red or Lighting In Red	Turned off	Lighting In Red	There is a possibility that the interior portion has become heated. Please turn the power off, and allow the unit to cool down at least 20 minutes. After the projector has sufficiently cooled down, please make confirmation of the following items, and then turn the power on again. <ul style="list-style-type: none"> • Is there blockage of the air passage aperture? • Is the air filter dirty? • Does the peripheral temperature exceed 35°C? If the same indication is displayed after the treatment, please change the lamp by referring to the section "Lamp".
Lighting In Green	Alternative blinking in Red		There is a possibility that the interior portion has become overcooled. Please use the unit within the usage temperature parameters (5°C to 35°C). After the treatment, reset the power to ON.
Lighting In Green	Simultaneous blinking in Red		It is time to clean the air filter, or there is no air filter. Please immediately turn the power OFF, and clean or change the air filter by referring to the section "Air Filter". After cleaning or changed the lamp, please be sure to reset the filter timer. After the treatment, reset the power to ON.

Phenomena that may easily be mistaken for machine defects

⚠WARNING ▶ Never use the projector if abnormal operations such as smoke, strange odor, excessive sound, damaged casing or elements or cables, penetration of liquids or foreign matter, etc. should occur. In such cases, immediately turn off the power switch and then disconnect the power plug from the power outlet. After making sure that the smoke or odor has stopped, contact your dealer or service company.

Before requesting repair, please check in accordance with the following chart. If the situation cannot be corrected, please contact your dealer or service company.

memo If the problem is not removed after described maintenance, please use the **FACTORY RESET** to reset all settings to factory default. This operation sometimes resolve your problem.

NOTE • Although bright spots or dark spots may appear on the screen, this is a unique characteristic of liquid crystal displays, and such do not constitute or imply a machine defect.

Phenomenon	Cases not involving a machine defect	Reference page
Power does not come on.	The electrical power cord is not plugged in. Correctly connect the power cord.	10
	The power switch is not set to the on position. Set the power switch to [] (On).	12
	The main power source has been interrupted during operation such as by a power outage (blackout), etc. Please turn the power off, and allow the unit to cool down at least 20 minutes. After the projector has sufficiently cooled down, please turn the power on again.	12
	Either there is no lamp and/or lamp cover, or either of these has not been properly fixed. Please turn the power off, and allow the unit to cool down at least 45 minutes. After the projector has sufficiently cooled down, please make confirmation of the attachment state of the lamp and lamp cover, and then turn the power on again.	31, 32
No pictures are displayed.	The lens cap is attached. Remove the lens cap.	4
	The signal cables are not correctly connected. Correctly connect the connection cables.	8, 9
	The brightness is adjusted to an extremely low level. Adjust the BRIGHT to a higher level using the menu function or the remote control.	16, 19

Phenomena that may easily be mistaken for machine defects (continued)

Phenomenon	Cases not involving a machine defect	Reference page
No pictures are displayed.	The PC cannot detect the projector as a plug and play monitor. Make sure that the PC's can detect a plug and play monitor using other plug and play monitor.	8
	If the connected PC has a DVI output, the driver software of the DVI board is too old. Consult with the dealer of your PC to install new software.	-
	The signal source cannot output both a DVI signal and a VGA signal simultaneously. Disconnect the VGA connection when you use the DVI input.	-
	If the output signal can be selected on the PC, it isn't selected properly Select the digital output for DVI connection.	-
Colors have a faded- out appearance, or Color tone is poor.	Color settings are not correctly adjusted. Perform picture adjustments by changing the COLOR TEMP, COLOR and/or TINT settings, using the menu functions.	18, 19
	COLOR SPACE setting is not suitable. Change the COLOR SPACE setting to AUTO, RGB, SMPTE240, REC709 or REC601.	24
Pictures appear dark.	The brightness and/or contrast are adjusted to an extremely low level. Adjust the BRIGHT and/or CONTRAST settings to a higher level using the menu function.	16, 18, 19
	The IRIS setting lowers the brightness. Set the IRIS to +10.	26
	The WHISPER function is working. Select the NORMAL to the item WHISPER in the SETUP menu.	26
	The lamp is approaching the end of its product lifetime. Replace the lamp.	32
Pictures appear blurry.	Either the focus and/or horizontal phase settings are not properly. Adjust the focus using the focus knob, and/or H PHASE using the menu function.	14, 22
	The lens is dirty or misty. Clean the lens by referring to the section "Caring For The Lens".	34

Warranty and after-service

If a problem occurs with the equipment, first refer to the “Troubleshooting” and run through the suggested checks. If this does not resolve the problem, please contact your dealer or the service company. They will tell you what warranty condition is applied.

ENGLISH

Specifications

NOTE • This specifications are subject to change without notice.

Item		Specification																								
Product name		Liquid crystal projector																								
Liquid Crystal panel	Panel size	1.8 cm (0.7 type)																								
	Drive system	TFT active matrix																								
	Pixels	921,600 pixels (1280 horizontal x 720 vertical)																								
Lens		Zoom lens F=1.8 ~ 2.4 f=20.0 ~ 31.9 mm																								
Lamp		150W UHB																								
Power Supply		AC100-120V/2.4A, AC220-240V/1.1A																								
Power Consumption		220W																								
Temperature range		5 ~ 35°C (Operating)																								
Size		340 (W) x 110 (H) x 280 (D) mm (Not including protruding parts) • Please refer to the figure of the section “TECHNICAL” of the end of this manual.																								
Weight (mass)		4.5 kg																								
Ports		<table border="0"> <tr> <td>RGB input ports</td> <td></td> <td>Control port</td> </tr> <tr> <td>Computer.....</td> <td>1</td> <td>CONTROL.....</td> </tr> <tr> <td>DVI-D.....</td> <td>1</td> <td></td> </tr> <tr> <td colspan="3">Video input ports</td> </tr> <tr> <td>Video</td> <td>1</td> <td></td> </tr> <tr> <td>S-Video</td> <td>1</td> <td></td> </tr> <tr> <td>Component Video.....</td> <td>1</td> <td></td> </tr> <tr> <td colspan="3">(Y, Cb/Pb, Cr/Pr)</td> </tr> </table>	RGB input ports		Control port	Computer.....	1	CONTROL.....	DVI-D.....	1		Video input ports			Video	1		S-Video	1		Component Video.....	1		(Y, Cb/Pb, Cr/Pr)		
RGB input ports		Control port																								
Computer.....	1	CONTROL.....																								
DVI-D.....	1																									
Video input ports																										
Video	1																									
S-Video	1																									
Component Video.....	1																									
(Y, Cb/Pb, Cr/Pr)																										
Optional parts	Lamp	DT00661																								
	Air filter	NJ09452																								
	Others	• Please consult your dealer.																								

