

Ultra Short Throw Laser Projector

Specifications		
Model name	MP-TW4001	MP-TW3001
Display system	3LCD	
Display device	Size of effective display area: 0.59", aspect ratio 16:10 Number of pixels: 1,024,000 pixels (1,280 horizontal × 800 vertical)	
Lens	Zoom: Digital zoom (1.35×) Focus: Powered	
Light source	Laser diode	
Screen size	60 ~ 100 inch (60 ~ 130 inch when no interactive function is used.)	
Light output (Brightness)	4,200 lm ¹	3,300 lm ¹
Contrast ratio (full white / full black)	500,000 : 1 ¹	
Speaker	16 W × 1 mono	
Displayable scanning frequency	Horizontal	Vertical
	15 ~ 106 kHz	50 ~ 120 Hz
Display resolution	Computer	VGA, SVGA, XGA, WXGA, SXGA, WXGA+, WXGA++, WSXGA+, UXGA, Full HD, Mac 16"
	Video	NTSC, NTSC4.43, PAL, SECAM, PAL-M, PAL-N, PALI(60 Hz), 480i@60, 480p@60, 576i@50, 576p@50, 720p@50/60, 1080i@50/60, 1080p@50/60
Terminals	HDMI IN: HDMI connector × 2 (HDMI IN 1 supports MHL input.) COMPUTER IN 1: Mini D-sub 15-pin connector × 1 COMPUTER IN 2 / MONITOR OUT: Mini D-sub 15-pin connector × 1 VIDEO IN: RCA connector × 1 AUDIO IN: 3.5 mm stereo mini connector × 2, RCA connector L/R × 1 AUDIO OUT: 3.5 mm stereo mini connector × 1 CONTROL IN (RS-232C): D-sub 9-pin connector × 1 LAN: RJ-45 connector × 1 USB-A: USB type A × 2 (PC-LESS Presentation or optional wireless adapter) USB-B: USB type B × 1 (USB Display and USB mouse control)	
Network	Wired: 100BaseTX / 10BaseT Wireless (Option ²): IEEE 802.11a/b/g/n/ac	
Operating temperature	0 - 40 °C ³ (The brightness of light source may be reduced automatically over 35 °C.)	
Operating humidity	10 - 80%RH (non-condensing)	
Power requirements	AC 100 - 120 V (50 / 60 Hz), 3.9 A AC 220 - 240 V (50 / 60 Hz), 2.0 A	AC 100 - 120 V (50 / 60 Hz), 3.0 A AC 220 - 240 V (50 / 60 Hz), 1.6 A
Power consumption	AC 100 - 120 V: 380 W AC 220 - 240 V: 380 W	AC 100 - 120 V: 300 W AC 220 - 240 V: 300 W
Standby mode power consumption	Less than 0.5 W ⁴	
Standard outside dimensions (W × H × D)	512 mm × 155 mm × 424 mm (20.1" × 6.1" × 16.7") (Including protrusions)	506 mm × 139 mm × 424 mm (19.9" × 5.5" × 16.7") (Excluding protrusions)
Weight	Approx. 7.8 kg (17.2 lbs.)	Approx. 7.6 kg (16.8 lbs.)
Accessories	Remote control with two AA batteries, Power cord, Computer cable, Adapter cover, User's manual, Security label, USB cable, Interactive pen(x2), AAA battery(x4), Pen tip(x4), Application DVD, Hook metal, Screw, Cable tie, HDMI cable holder, Ferrite core	
Optional parts	Air filter: UX43251 Mounting accessories: HAS-WM06 (Wall mount, supported image size: 70~110 inch) HAS-9110 (Bracket for fixing mount) HAS-304H (Long adapter for fixing mount)	USB wireless adapter: USB-WL-5G ⁵ Interactive pen: I-PEN4 Finger touch unit: FT-01B

*1: When PICTURE MODE is set to DYNAMIC, and LIGHT OUTPUT is set to NORMAL 100%. *2: Optional wireless adapter is needed. *3: 0 - 40 °C at altitude from 0m to 1,600 m. 0 - 35 °C at altitude from 1,600 m to 3,048 m. *4: SAVING mode disables the functions of MONITOR OUT, AUDIO OUT, speaker sound, network communication, RS-232C control except POWER ON command, etc. in standby. *5: The availability of the USB-WL-5G varies depending on the country and the region.

—Design and specifications are subject to change without notice.

• The projected images and comparison photos in this catalog are simulations. • LCD panels, polarizers and other optical components and cooling fans may need replacement after prolonged usage. For more details, please consult a sales representative. • Do not use in places where there is a lot of water, dampness, steam, dust, soot or tobacco smoke. This may result in fire or malfunction. • Optical components (light source, LCD panel, polarizing plate, PBS [polarizer beam splitter]) have limited service lives. They must be repaired or replaced if they are used for a long period of time. • During use and immediately after use, do not touch anywhere near the vents as these parts are extremely hot. • Optical components other than the light source: If the projector is used for six hours or more per day, they may need to be replaced in less than a year. • LCD panel: If the projector is used continuously for six hours or more, its replacement cycle may be shortened. • Each product may have differences of color, brightness and focus due to manufacture variation. • Crestron® and Crestron RoomView® are registered trademarks of Crestron Electronics, Inc. in the United States and other countries. • DICOM is the registered trademark of the National Electrical Manufacturers Association for its standards publications relating to digital communications of medical information. • MHL, the MHL logo, and Mobile High-Definition Link are trademarks or registered trademarks of MHL, LLC in the United States and other countries. • HDMI, the HDMI Logo, and High-Definition Multimedia Interface are trademarks or registered trademarks of HDMI Licensing Administrator, Inc. in the United States and other countries. • All other trademarks are the properties of their respective owners.

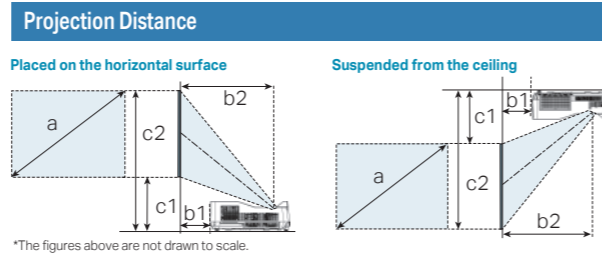
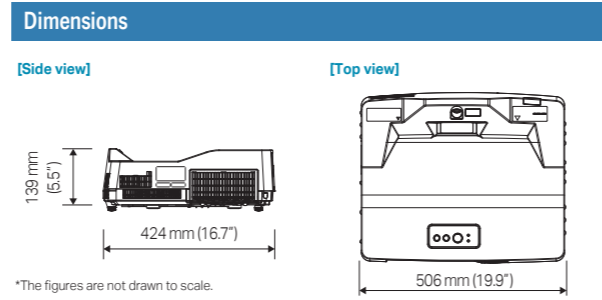

Screen size(diagonal) type (inch)	Projection distance				Screen height				
	a	b1		b2		c1		c2	
60	1.5	0.079	3.1	0.413	16.3	0.237	9.3	1.044	41.1
70	1.8	0.149	5.9	0.483	19.0	0.261	10.3	1.203	47.4
80	2.0	0.219	8.6	0.553	21.8	0.285	11.2	1.362	53.6
90	2.3	0.289	11.4	0.623	24.5	0.309	12.2	1.521	59.9
100	2.5	0.359	14.1	0.693	27.3	0.334	13.1	1.680	66.1
110	2.8	0.428	16.9	0.763	30.0	0.358	14.1	1.839	72.4
120	3.0	0.498	19.6	0.833	32.8	0.382	15.0	1.997	78.6
130	3.3	0.568	22.4	0.903	35.5	0.406	16.0	2.156	84.9

NOTE The Interactive function does not operate normally when a projected image is over 100 type (inches).

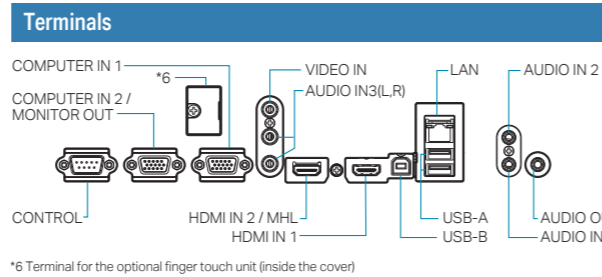

Environment

- ▶ Compliance with EU Directive RoHS¹
- ▶ Power saving mode engaged during standby
- ▶ Long Life mode
- ▶ No use of mercury lamp

¹RoHS is the acronym of "Directive 2011/65/EU of the European Parliament and of the Council of 8 June 2011 on the restriction of the use of certain hazardous substances in electrical and electronic equipment."

LASER RADIATION
DO NOT STARE INTO BEAM
CLASS 2 LASER PRODUCT
Wavelength: 449-461 nm
Max. Output: 36.5 mW
IEC 60825-1:2007

RAYONNEMENT LASER
NE FIXEZ PAS LE FAISCEAU
PRODUIT LASER DE CLASSE 2
Longueur D'onde: 449-461 nm
Sortie max.: 36.5 mW
IEC 60825-1:2007

雷射輻射
請勿凝視光束
2類雷射光產品
波長: 449-461 nm
最大輸出: 36.5 mW
IEC 60825-1:2007

CLASS 1 LASER PRODUCT
PRODUIT LASER DE CLASSE 1
LASERPRODUKT DER KLASSE 1
IEC/EN 60825-1:2014

RG2

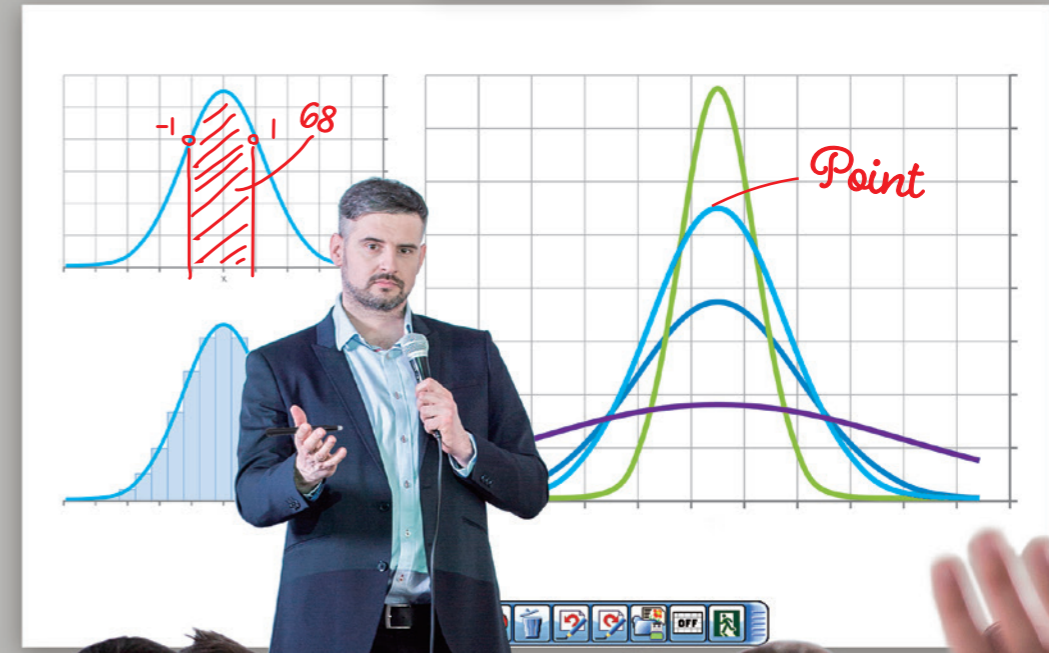

Maxell 3LCD Ultra Short Throw laser projector delivers a large and vivid image with the unit placed closer to the screen.



*Projected images are simulations.

An interactive function with enhanced operability and functionality



*Projected images are simulations.

Advanced Writing/Drawing Capabilities

PC less Drawing

T Series projector comes with a built-in drawing function allowing you to directly draw and write on the projected screen without a PC.

Convenient Painter Tool

Equipped with the Pen, Eraser, Undo, Redo functions. You can also change the pen color and thickness. With the easy-to-use Painter tool bar, you can teach classes smoothly.



Save and Open Drawn Screens

You can save the image drawn on the projector screen. This enables you to easily manage what you've taught in the past.

Multiple Interactive Pens

With up to 6 interactive pens pupils can do more than just watch - they can interact with the onscreen content. Let them enjoy providing answers, showing their understanding and becoming involved in lessons as never before.



Finger Touch (Option)

The T Series projector incorporates the optional finger touch unit that enables the projector to detect finger touch activity on the screen area. It allows users to annotate and interact with the material presented. Instead of simply showing static images, students and teachers can interact with on screen material for hands-on interactivity that brings learning to life.

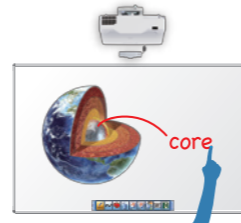

* When using the finger touch unit at bright environment, auto calibration may not be used.
* Please use the finger touch unit on a flat screen.
* The finger touch unit may not be used in locations where there is sunlight or light from an incandescent light source.

Interactive Software

This product includes a drawing application that offers more sophisticated drawing functions.

Neatly Convert Letters or Figures

You can automatically convert freehand shapes into geometric objects and handwriting into text on the projected image. These operations are easily accomplished with the interactive pen.



Select a Variety of Useful Tools

The interactive pen lets you operate a compass, ruler, protractor, stopwatch and other useful tools on the projected image, making lessons even easier to understand.



System requirements for drawing application

Windows®

• **CPU:** Intel® Core™ Duo (1.8GHz or faster) • **HDD:** 2 GB free space • **Memory:** 2 GB or more • **Display:** 32 bit • **OS:** Windows® 7 (32/64bit), Windows® 8.1 (32/64bit), Windows® 10 (32/64bit) (The drawing application has been verified with the latest service pack at the time of release. The drawing application does not support Windows® Tablet PC Edition and Server Edition.) • **Network:** Internet-connected environment • **Application:** Internet Explorer® 11, Microsoft® Word 2013/2016, Microsoft® Excel® 2013/2016, Microsoft® PowerPoint® 2013/2016, Adobe® Reader® X/XI, Adobe® Acrobat® Reader® DC, Adobe® Flash® Player 18 • **Others:** DVD-ROM drive, Video cards supporting hardware overlay feature (for using the movie features) [When using the Webcam function] DV (digital video devices, DV camera, D-VHS etc.), Capture Devices which support DirectShow with WDM drivers [For hosting a remote conference] • **CPU:** Intel® Core™ i3 or greater • **HDD:** 2 GB or more free space • **Memory:** 2 GB or more • **Others:** TCP/IP Network of 54 Mbps or greater

Macintosh

• **CPU:** Intel® Core™ Duo (1.8GHz or faster) • **HDD:** 2 GB free space • **Memory:** 2 GB or more • **Display:** High Color (16 bit) or more • **OS:** Mac OS X 10.10/10.11/10.12/10.13 • **Network:** Internet-connected environment • **Application:** Apple QuickTime 7.6 or later, Adobe® Flash® Player 18 • **Others:** DVD-ROM drive [For hosting a remote conference] • **CPU:** Intel® Core™ i3 or greater • **HDD:** 2 GB or more free space • **Memory:** 2 GB or more • **Others:** TCP/IP Network of 54 Mbps or greater

LINE UP

Tseries
Ultra Short Throw



MP-TW4001

WXGA 4,200 lm



* Local availability may be limited.



MP-TW3001

WXGA 3,300 lm



High Reliability and Stability

Long Life 20,000 hour Laser Light Source

Maxell's laser light source projectors have 20,000 hours*1 of light source life. Use for 40,000 hours*1 can be achieved in LONG LIFE 2 mode. Also, users may select their desired operation mode. Furthermore, in addition to the light source, the phosphor wheel is also dust resistant, suppressing brightness level reduction by preventing dust from coming into contact with the optical parts. Users can enjoy using the projector for long periods of time while maintaining its brightness.

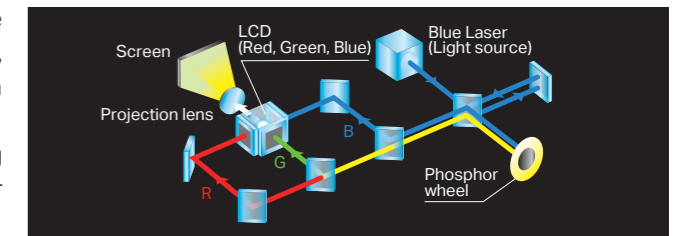

*1 For laser light source. The value is an estimate and may vary depending on the use environment or use condition.

LIGHT OUTPUT	Brightness*2		Light source life*3	Noise*4
	MP-TW4001	MP-TW3001		
NORMAL	4,200 lm	3,300 lm	20,000 hours	34 dB
LONG LIFE 1	3,150 lm	2,470 lm	30,000 hours	
LONG LIFE 2	2,100 lm	1,650 lm	40,000 hours	
WHISPER	2,100 lm	1,650 lm	20,000 hours	

Brightness Deterioration Comparison between Light Output Modes

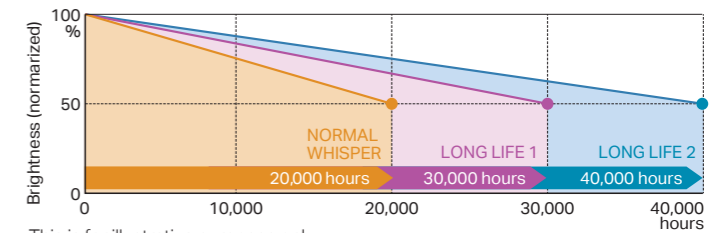

*2 These are reference values and may vary depending on products. *3 The values are an estimate and may vary depending on the usage environment or use condition.

*4 Reference values when used in an ambient temperature of 23 °C. The noise level varies by the projector model, installation environment, and use condition.

Installability

Reduced Glare and Shadows

These projectors feature Ultra Short Throw, for projecting a 2.0 m (80 inch) image from only 55 cm (21.8 inches) onto a wall or screen. The Ultra Short Throw greatly reduces glare from the projector's light source, making it easier for a teacher or presenter to see the audience. The audience also has a clearer view because the shadows of the teacher's or presenter's hands and body are minimized. The result is a better classroom or meeting room experience for everyone.

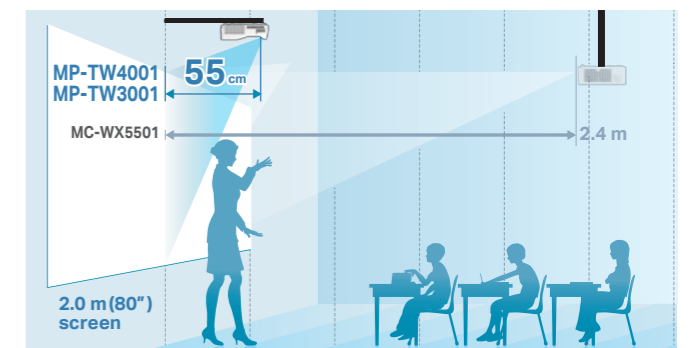

This figure is not drawn to scale.

Convenient Functions

Easy Schedule Setting

You can schedule routine and special projector events, including power on, power off, input selection and other settings.

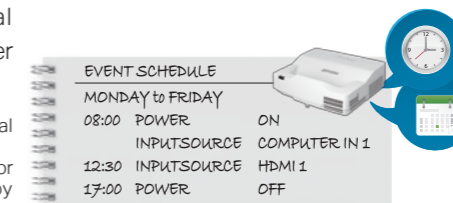

* This function requires a coin battery for the internal clock or connecting to an SNTP server on network.

* When STANDBY MODE is set to NETWORK (WOL) or SAVING, this function (ex. POWER ON) at standby mode will not be operated.

Wireless Dual Band Support (Option)

Provides a stable wireless network environment by supporting wireless dual band (2.4 GHz / 5 GHz).



* Dual Band may be restricted in some countries and regions.

Other Functions

- Quick Start
- DICOM® Simulation Mode*5
- 16W Internal Speaker
- MHL connectivity
- Smart Device Control & Monitoring
- Moderator Control Mode
- PIN lock
- Key lock

*5 This projector is not a medical device and is not compliant to the DICOM standard, and neither the projector nor this function should be used for medical diagnosis.