

User Manual



Model: HILF65101
65" Interactive LED/LCD

Contents



1. Important safety Instruction	3
1.1 Safety precautions	
1.2 Maintenance	
2. Introduction	8
3. Product Description	9
3.1 Front View	
3.2 Rear View	
3.3 Connection	
4. Remote Control	11
5. OSD menu Description	12
6. Product Specifications	21
7. Product Dimensions	23
8. Troubleshooting	24
8.1 Product Self-Diagnosis	
8.2 Before Requesting Service	

1. Important Safety instructions

[SAFETY WARNING]

- To reduce the risk of fire or electric shock, do not expose this product to rain or moisture.
- To prevent injury, this product must be securely attached to the floor/wall in accordance with the installation instructions.
- To reduce the risk of electric shock, do not remove the back cover
- Refer servicing to qualified service personnel if needed.

► Icons used in this manual

	CAUTION RISK OF ELECTRIC SHOCK. DO NOT OPEN.			The lightning flash and arrowhead within the triangle indicates that there is dangerous voltage inside the product.
				The exclamation point within the triangle indicates that there are important instructions accompanying the product.

[WARNING] means,

If you ignore the warning message, you may be seriously injured or there is a possibility of accident or death.

[CAUTION] means,

If you ignore the caution message, you may be slightly injured or the product may be damaged.

[NOTE] means,

The note helps you understand and use the product safely. Please read the note carefully before using the product.

► When moving the product, please grab the handles behind and the bottom of the product as shown below picture.

- The product must keep horizontal and upright position when moving.
- Do not hold the corner of the product when you grab the bottom of the product.

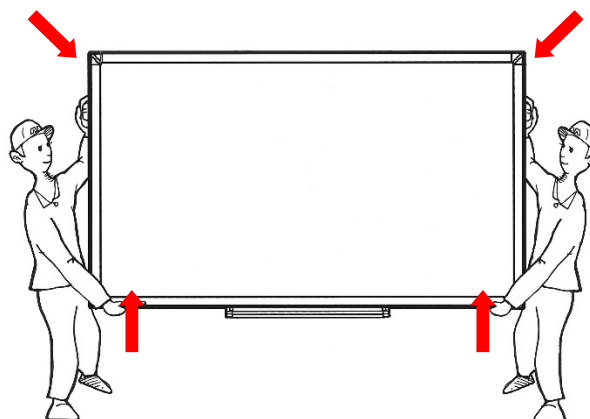

1.1 SAFETY PRECAUTION

Note) The color and design may differ by each model and the product specification are subject to change without notice for performance enhancement.

1.1.1 Power

[Warning]

- Do not use damaged power cord, plug nor loose socket. It may cause electric shock or fire.
- Do not connect multiple devices into a single s socket. It may cause fire due to overheating.
- Do not touch with wet hands when remove or plug the power cord to avoid electric shock.
- Insert the power plug into socket firmly. It may cause fire when the connections are unstable.
- Connect the power cord to a grounded wall socket. There is risk of electric shock or injury.
- Do not bend nor pull the power cord and place heavy objects over the power cord. It may occur cord damage and this may result in fire.
- Please clean only with dry cloth when the plug pin or socket are dusty. It may cause fire.

[Caution]

- Do not unplug the power plug while the product is operating. It may damage the product due to electric shock.
- Only a power cord specified by product manufacturer are recommended.
Do not use the power cord from other devices. It may cause electric shock or fire.
- Hold the plug itself when unplugging the power plug from the wall socket. If not, there is risk of electric shock or fire.
- Before moving or installing this product, be sure to turn off the power and disconnect the power cord. To turn this product off completely, you must pull the power plug out of the wall socket. Consequently, the power plug must be easily and readily accessible at all times.

1.1.2 Installation

[Warning]

- Do not install near any heat sources such as radiators, or other devices that produce heat. It may cause electric shock or fire.
- When mounting a product on the wall, make sure not to install the product by hanging the power and signal cables on the back of it.
- Consult with your local dealer or specialized engineer to mount the product on the wall, and use the screws and wall mounts that meet the VESA standard. Any damages or injuries by misuse or using an improper accessory are not covered by the warranty.
- Leave a 10 cm (4 inches) (minimum) space from the wall for proper ventilation. If not, it may cause fire.
- Keep the packing anti-moisture material or vinyl packing out of the reach of children. Anti-moisture material is harmful if swallowed. If swallowed by mistake, force the patient to vomit and visit the nearest hospital. Additionally, vinyl packing can cause suffocation. Keep it out of the reach of children.

- Please note that the product must be supported on proper stands or installed according to the manufacturer's recommendations. The product that are inappropriately situated on unstable shelves, inclined planes, or vibrating places, etc., may fall over, resulting in injury.
- To reduce the risk of fire or electrical shock, do not expose this product to rain, moisture or other liquids or dust. It may cause electric shock or fire.
- Keep the product away from direct sunlight.
- Keep the product of the reach of children and install on the stable and flat place. NEVER allow children to climb on or play on the product or the furniture and stands on which the product is placed.

[Caution]

- Do not allow an impact shock or any objects to fall into the product, and do not drop anything onto the screen.
- Make sure the product is turned off, unplugged, and all cables have been removed. It may take more than 4 people to than carry.

Do not press or put stress on the front panel of the product.

- If the product is installed in a place where the operating conditions considerably, a serious quality problem may occur due to the surrounding environment. In this case, install the product only after consulting our dealer about the matter. (Places exposed to microscopic dust, chemicals, too high or low temperature, high humidity, airports or stations where the product is continuously used.)

1.1.3 Cleaning

[Warning]

- Clean the product with a soft dry cloth.
- Avoid cleaning the product by spraying water onto it. If water enters the product, it may result in fire, electric shock or a problem with the product.
- Avoid scratching the screen with your fingernails, marker pen or a sharp object.
- In case of the products that attached additional sensors reflector in the bottom of the screen, do not attempt to clean with water. Use a soft brush to remove the dust or dirt.
 - » If it was wet in water, touch function can cause malfunction and failure.
- In case of the products that attached additional purple sensor filter on the right and left screen both

[Caution]

- Do not push, rub, or hit the surface with your fingernail or a sharp object, as this may result in scratches on the screen and image distortions.
- Do not use any chemicals, such as waxes, benzene, alcohol, thinners, insecticides, air fresheners, or lubricants, as these may damage the screen's finish and cause discoloration.
- Do not spray liquid onto the surface. If water enters the product, it may result in fire, electric shock, or malfunction.

1.1.4 General Usage

[Warning]

- To reduce the risk of electric shock, do not open the cover or back. No user serviceable parts inside. Refer to qualified service personnel.
- Before moving or lifting the product, disconnect the power cord and all cables.
- The route cords and cables connected to the product so that they cannot be tripped over, pulled or grabbed.
- Do not stick metal objects or any other conductive material into the power cord. Do not touch the end of the power cord while it is plugged in. It may result in fire, electric shock.
- Unplug this product during lightning storms or when unused for long periods of time.
- Do not block any ventilation openings. Install in accordance with the manufacturer's instructions.
- To reduce the risk of fire or electrical shock, do not expose this product to rain, moisture or other liquids. Do not touch the product with wet hands. Do not install this product near flammable objects such as gasoline or candles, or expose to direct air conditioning.
- NEVER allow children to climb on or play on the product or the furniture on which it is placed. It may cause severe injury to children.
- Use only with a cart, stand, tripod, bracket, or table specified by the manufacturer, or sold with the product. When a cart is used, be careful when moving the cart/product combination to avoid injury from tip-over.
- Install where it cannot be pushed, pulled over or knocked down.
- It is recommended to move the product in the box or packing material that originally came in.
- When holding the product, the screen should face away from you to avoid damage.

[Caution]

- If a fixed image displays on the screen for a long period of time, it will be imprinted and become a permanent disfigurement on the screen. This is image burn or burn-in and not covered by the warranty.
- Avoid displaying a fixed image on the screen for a long period of time (2 or more hours for LCD) to prevent image burn. Recommend to power off or set the screen saver mode when not in use.
- When watching the screen, take 5 to 15 minute breaks every hour. Viewing screen for a long period of time may cause fatigue or eye strain.
- Take care not to touch the ventilation openings. When watching the screen for a long period, the ventilation openings may become hot. This does not affect the performance of the product or cause defects in the product.
- Do not install this product on a wall if it could be exposed to oil or oil mist. This may damage the product and cause it to fall.
- To install batteries in remote control, open the battery cover, replace batteries matching (+) and (-) ends to the label inside the compartment, and close the battery cover. Failure to match the correct polarities of the battery may cause the battery to burst or leak, resulting in fire, personal injury, or ambient pollution.
- To prevent to swallow the small accessories for children, keep the accessories out of the reach of children.

- ※ The product must keep horizontal and upright position when moving. Hold the top and bottom of the frame firmly. Handles are only for the supporting purpose.
- ※ When attaching the stand to the set, place the screen facing down on a cushioned table or flat surface to protect the screen from scratches by more than 2 people,
- ※ Make sure that the screws are fastened tightly. (If they are not fastened securely enough, it may tilt forward after being installed.)

1.2 MAINTENANCE

1.2.1 Cleaning

- When cleaning, unplug the power cord and wipe gently with a soft dry cloth to prevent scratching.
- Do not spray water or other liquids directly on the screen as electric shock may occur.
- Do not clean with chemicals such as alcohol, thinners, or benzene.

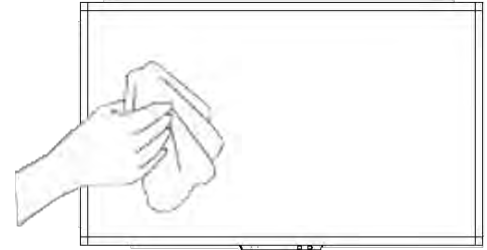

1.2.2 Installation

- Leave a 10 cm (4 inches) (minimum) space from the wall for proper ventilation. If not, it may cause fire or malfunction due to the high temperature product inside.

[When attaching the stand]

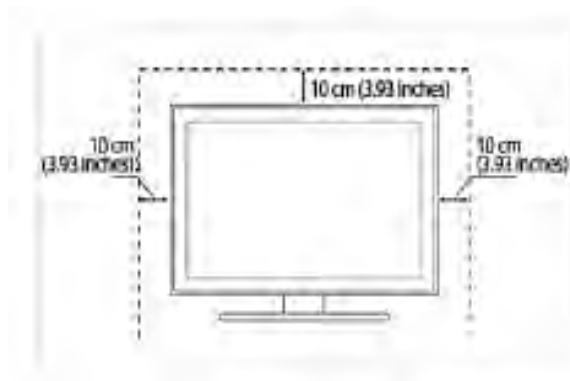

[When mounting on a wall]

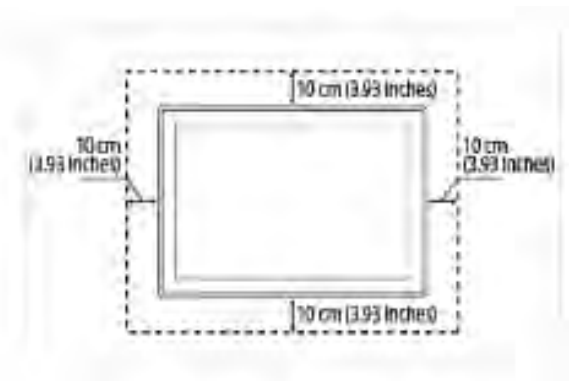

1.2.3 Panel

- Avoid displaying a fixed image on the screen for a long period of time (2 or more hours for LCD) to prevent image burn. Recommend to power off or set the power saving mode or screen saver when not in use.
- Due to technological constraints of the Panel manufacturer, the images generated by this product may appear either brighter or darker than normal by appr. 1ppm (parts per million) pixel.

The number of sub-pixels of a panel by size: The number of Sub-Pixels = Max. Horizontal Resolution x Max. Vertical Resolution x 3.

For example, if the maximum resolution is 1920 x 1080, the number of sub-pixels is 1920 x 1080 x 3 = 6,220,800.

2. Introduction

- ▶ Check your product box for the following items. If there are any missing accessories, contact the local dealer where you purchased your product.
The illustrations in this manual may differ from the actual product and item.



LCD/LED Display



User Manual



Warranty Card



HDMI Cable



USB Cable(for TOUCH)



Power Cable

Accessory



Remote Controller



Battery 1.5 V(AAA)



PEN x 2

3. Product Description

3.1 FRONT VIEW

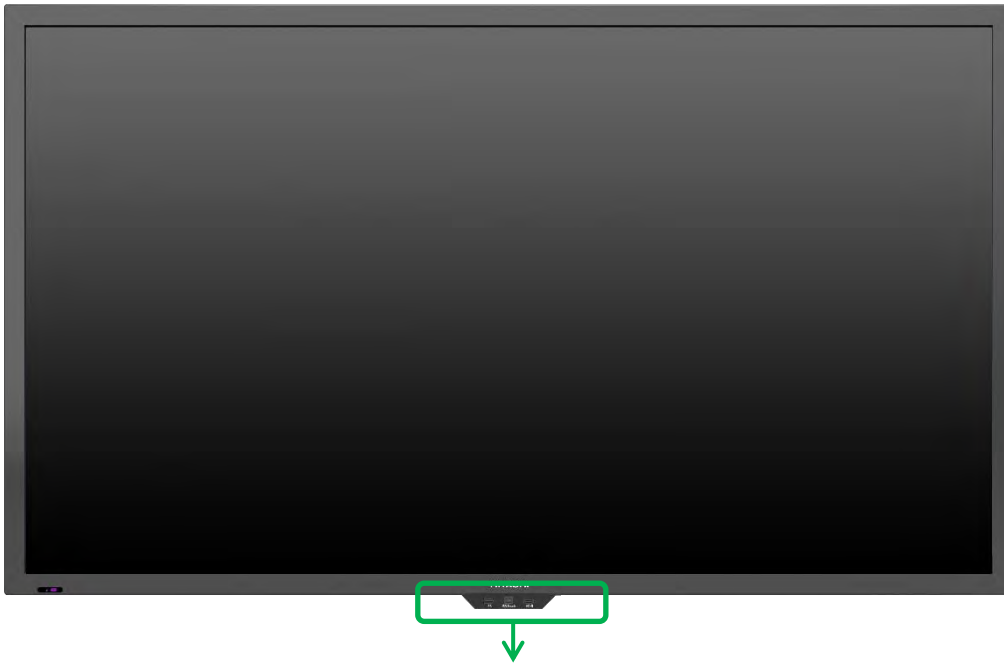

① USB ② TOUCH ③ HDMI

3.2 REAR VIEW

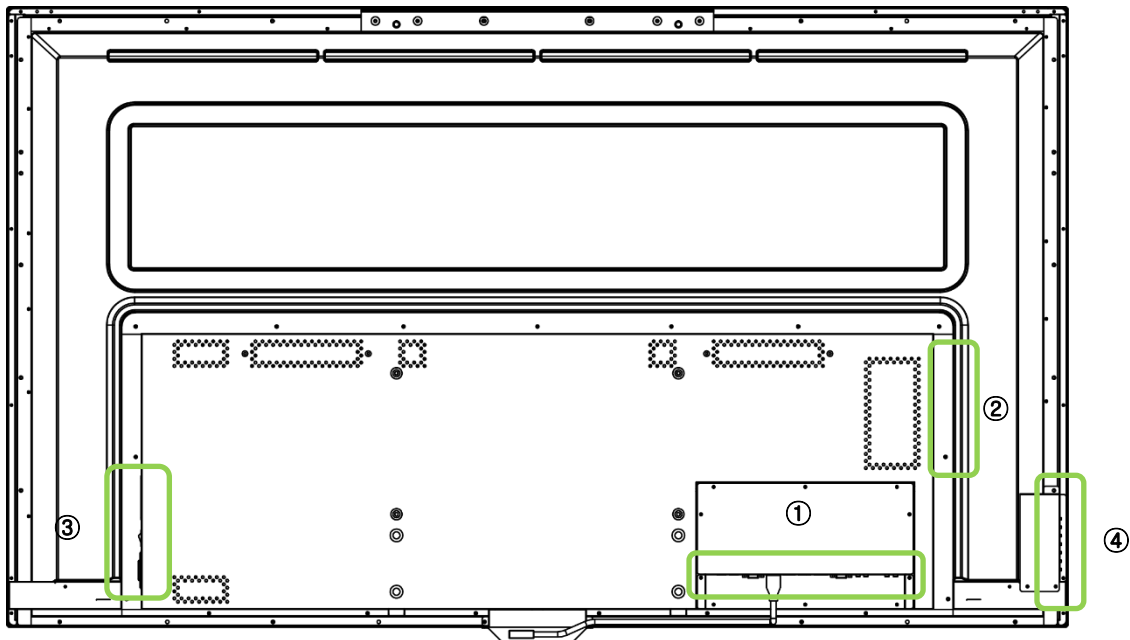

- (a) USB for Touch(Option)
- (b) USB for Touch
- (c) RS232C
- (d) HDMI 1 Input
- (e) HDMI 2 Input
- (f) DISPLAY PORT Input
- (g) VGA Input
- (h) PC AUDIO Input
- (i) AUDIO LINE Out
- (j) SPEAKER Out R. (10W , 8 Ohm)
- (k) SPEAKER Out L. (10W , 8 Ohm)

② When you need to install OPS PC.

There is a slot on ② for OPS PC. When you need to install OPS, remove screws and existing cover first and screw up again after mounting OPS PC in the slot.

③

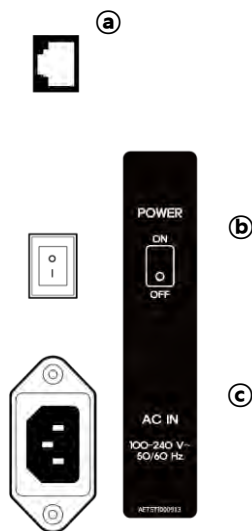

- (a) LAN
- (b) Power Switch : ON / OFF
- (c) AC IN: 100V~ 240V, 50/60Hz

④



- Power: ON / OFF
- Menu: Display the main screen menu
- Source: Display Port, HDMI1, HDMI2, HDMI3, HDMI Front, HDMI OPS, PC, USB
- Vol +: Volume Up (Right)
- Vol -: Volume Down (Left)
- ▲: Move Up
- ▼: Move Down

4. Remote Control



Key Name	Description
⏻/⏻	Power ON/OFF.
SOURCE	Activates OSD menu of input source selecting. Navigates input source.
▲	Navigates upper menu in main OSD menu. Navigates input source.
▼	Navigates down menu in main OSD menu. Navigates input source
▶	Navigates next menu in main OSD menu.
◀	Navigates before menu in main OSD menu.
OK	Select the highlighted menu option.
MENU	Activates main OSD menu.
EXIT	Escapes main OSD menu.
FREEZE	Allows you to capture and freeze an image from a moving image that you are watching.
VOL+	Volume UP
VOL-	Volume Down
MUTE	Toggles sound status of speaker.

4.1 How to insert battery.

Insert the battery into proper polarities
Battery model: Battery 1.5V (AAA)

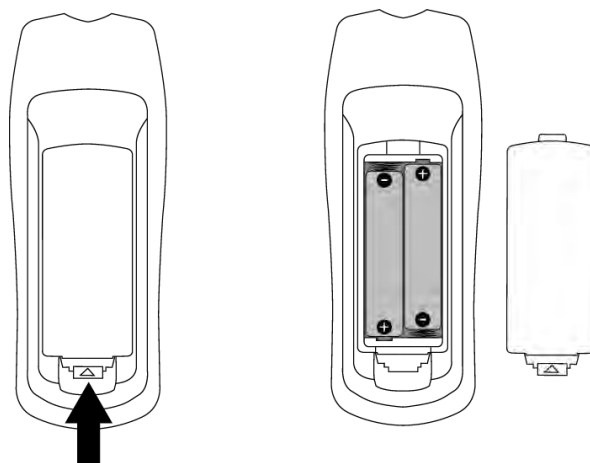

5. OSD Menu Description

5.1 Menu Overview

In this menu system, there are several ways to customize the menu settings provided. If you press the MENU button, only the first and second level of the menu system will appear on the monitor screen. The third level can be displayed by pressing SELECT.

1) To show and hide the menu:

Press the MENU button on the Remote Control to display the menu.

Press of the MENU button will take you back to monitor viewing.

2) To go to advance to the next menu:

Press OK on the Remote Control.

3) To go back to the previous menu:

Press MENU on the Remote Control.

4) Typical Menu Operation

- Press MENU button: The main menu will appear.
- Use to select the desired menu option (icon).
- While the desired menu option is selected, press OK to move to the second level.
- Press OK to move to the third level: Some menu options require additional steps.
- Press MENU to return to the previous menu.

Setup Menus

- ◆ Press the [MENU] Button. The OSD Main MENU will be shown.



- ◆ Entering the SETUP MENU

Press the ▲/▼ buttons to highlight SETUP and press the OK Button.

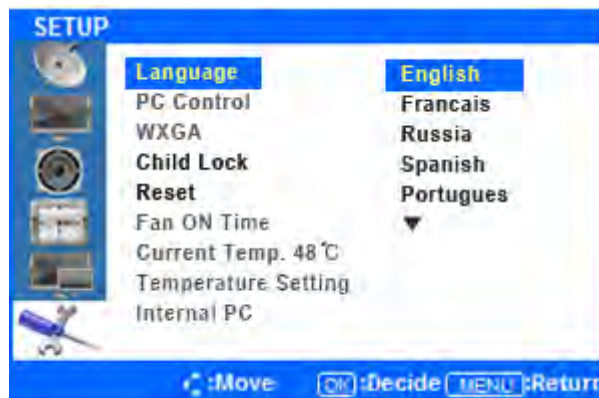

- ◆ Change the OSD Language

Press the ▷ buttons to select Language, and press the OK button to view and select available languages. Use the ▲/▼ buttons to highlight the language you would like to use and press the OK button to select it.



- ◆ Setup Child Lock (deactivate display buttons)

Press ◀ or the Menu Button to move or go back to the previous menu options.

Press the ▲/▼ buttons to highlight Child Lock, and press the OK Button.

Press the ▷ buttons to select ON or OFF. Press the OK button to choose either option. ON will lock the display's buttons so that you can only control through the remote.



- ◆ Setup Reset

Press ◀ or the Menu Button to move or go back to the previous menu options.

Press the ▲/▼ buttons to highlight Reset. Press the OK Button.

Press the ▷ buttons to select On Off, and press the OK button to confirm. Selecting Reset On will return all OSD menu settings to their factory defaults. Selecting Reset Off will cancel and exit the menu.



◆ Internal PC Setting

Internal PC will be automatically set up according to user PC type (OPS or Desktop, Laptop)

Input Menu

- ◆ Press the [MENU] Button.
The OSD Main MENU will show.



- ◆ Entering the Input MENU

Press ▲/▼ Button to highlight Input, Press the OK button to OK and view the available settings.



- ◆ Input source select

Press the ▷ buttons to highlight either VGA/OPS/HDMI2/HDMI1/DP. Once the desired input is highlighted, press the OK button to select it.

Only sources that are connected to the display can be selected.

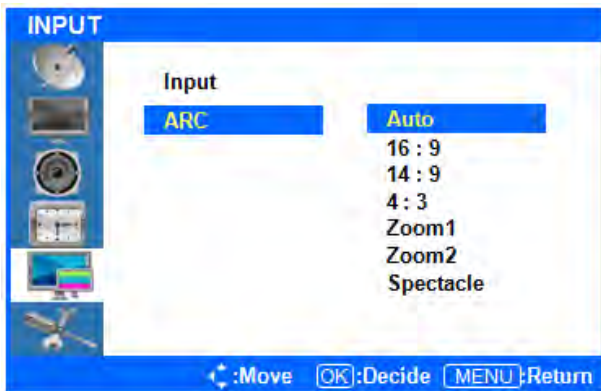

- ◆ Selecting the screen ratio

Press ◀ or the Menu Button to move or go back to the previous menu options.

Press the ▲/▼ buttons to highlight ARC (Auto Ratio Control), and press the OK button to view the available settings.

Press the ▷ buttons to select either AUTO/16:9/ 4:3. After highlighting the desired screen ration, press the OK button to select it.

After finishing the adjustment, Press the [Exit] Button to exit the OSD MENU.

Picture Menus

- ◆ Press the [MENU] Button. The OSD Main MENU will be shown.



◆ OK the PICTURE MENU

Press the ▲/▼ buttons to move through options in the PICTURE Menu. When you have moved to the option you would like to adjust, press the OK button and you will OK its settings.



◆ Adjustment CSM(Color Status Mode)

Press the ▲/▼ buttons to move to CSM. Press the OK Button to select it.

Press the ▷ buttons to move to either Cool, Normal, Warm, or User. Cool, Normal and Warm are preset color options. If you want to adjust the color settings individually, select USER and press the OK Button.



◆ Custom adjustment CSM

Press the ▷ buttons to highlight the Red, Green or Blue level. Next, press the OK button to select one of them.

Once selected, press the ▷ buttons to adjust the Red, Green, or Blue level.



◆ Picture Select mode

Press **◀** or the **Menu button** to move or go back to the previous menu options.

Press the **▲/▼** buttons to highlight **PSM** (Picture Status Mode), and press the OK button to see the available options.

Press the **▷** buttons to select highlight either Dynamic/Standard/Mild/Game/User, and press OK to select one. User is the default setting.



◆ Backlight Adjustment

Press **◀** or the **Menu Button** to move or go back to the previous menu options.

Press the **▲/▼** buttons to highlight **Backlight**, and press the OK button to change the setting.

Press the **▷** buttons to change the setting.

Note that the backlight value is related to power consumption. If you set your backlight at a higher level, you may be using more energy.



◆ Contrast and Brightness Adjustment

Press **◀** or the **Menu Button** to move or go back to the previous menu options.

Press the **▲/▼** buttons to highlight **Contrast** or **Brightness**, and press the OK button to change either of their settings.

Press the **◀/▷** buttons to adjust both the Contrast and Brightness levels.



◆ Color Adjustment

Press **◀** or the **Menu Button** to move or go back to the previous menu options.

Press the **▲/▼** buttons to highlight **Color** and press the OK button to change either of their settings.

Press the **◀/▷** buttons to change the setting.



◆ Sharpness Adjustment

Press **←** or the **Menu Button** to move or go back to the previous menu options.

Press the **▲/▼** buttons to highlight **Sharpness** and press the **OK** button to change either of their settings. Press the **◀/▶** buttons to change the setting.

Color mode and sharpness modes are available when you connect HDMI.

Sound Menus

◆ Press [MENU] Button. The OSD Main MENU will be shown.

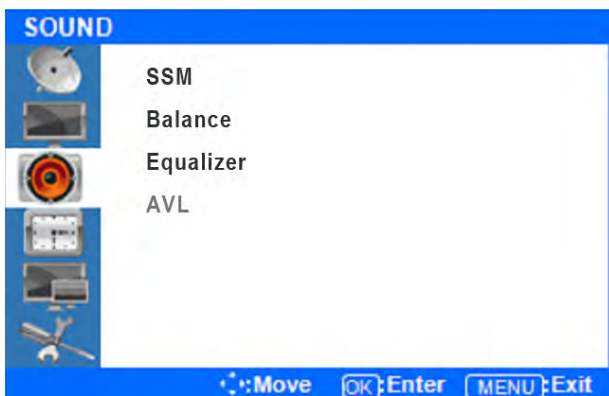

◆ Entering the Sound MENU

Press the **▲/▼** buttons to move up to the **SOUND** Menu. Press the **OK** button to OK the menu.

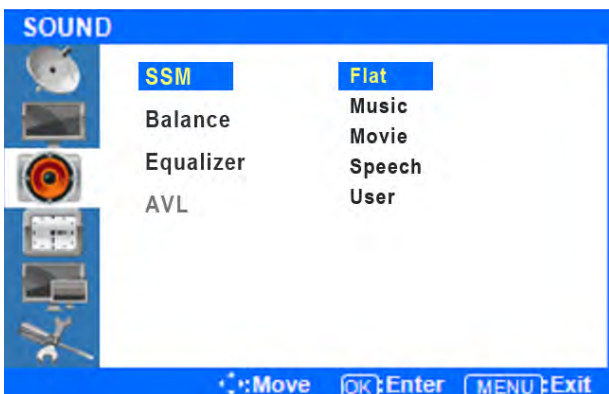

◆ Select Sound Status Mode

Press the **▶** buttons to move up to the **SSM (Sound Status Mode)** Menu, and press the **OK** button to view the settings. Press **▶** Button to select either Flat/Music/Movie/Speech/User, and press the **OK** button to select one.

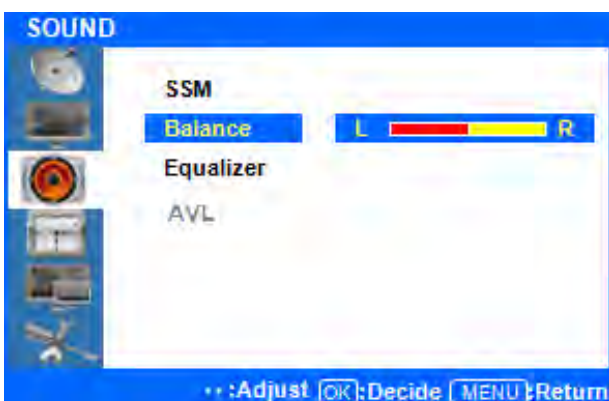

◆ Sound Balance

Press **←** or the **Menu Button** to move or go back to the previous menu options.

Press **▲/▼** Button to highlight the **Balance** Menu, and press the **OK** button to adjust the settings.

Press the **▶** buttons to adjust the **Left/Right Balance** value.

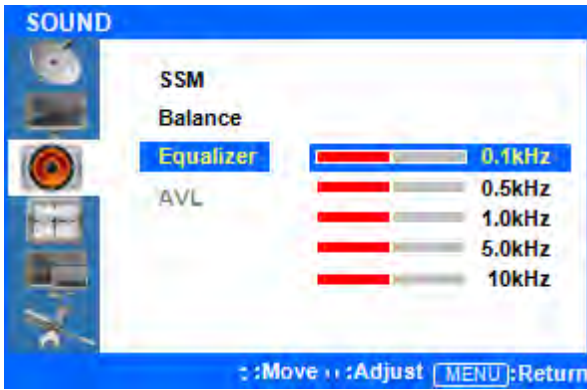

◆ Equalizer Adjustment

Press ◀ or the Menu Button to move or go back to the previous menu options.

Press ▲/▼ Button to highlight the Equalizer Menu, press the OK button to view the settings.

Press the ▷ buttons to highlight one of the 0.1/0.5/1.0/5.0/10kHz values. Press the OK button to select the value and change its setting.

Press the ◀/▷ buttons to adjust the frequency setting.

AVL mode is not supported.

After finishing your adjustments, press the [Exit] button to exit the OSD MENU.

Time Menus

Setup your system's clock and automatic ON/OFF times.

◆ Press the [MENU] Button.

The OSD Main MENU will be shown.

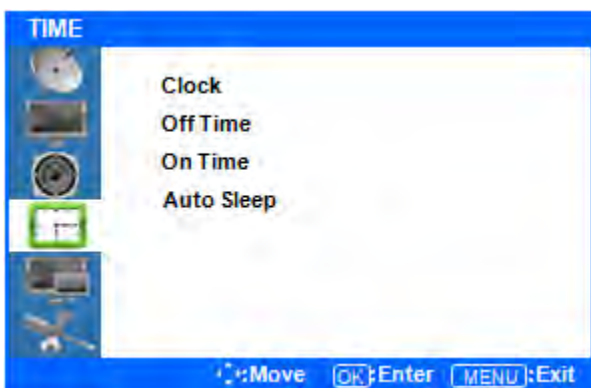

◆ Entering the TIME MENU

Press the ▲/▼ buttons to move up to the TIME Menu. Press the OK button to view the options in the menu.

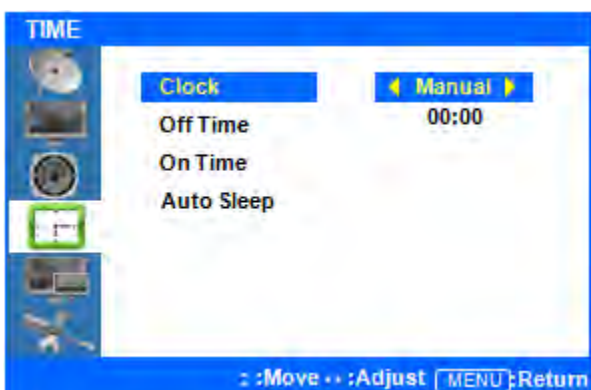

◆ Setup System Clock

Press the ▷ buttons to highlight the Clock Menu. Press the OK button to view and adjust the time setting. Your display will not automatically detect the time. You must set the time manually.

Press the ▷ buttons to highlight Manual, and press the OK button to select it.

Press the ▲/▼ buttons to adjust the time, and press the OK button to confirm it.

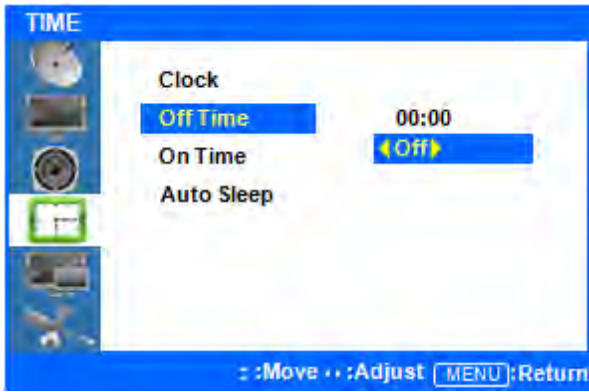

◆ Setup System OFF Time

Press ◀ **or the Menu Button** to move or go back to the previous menu options.

Press the ▲/▼ buttons to highlight Off Time, and press the OK button to select it.

Press the ▷ buttons to highlight Off, and press the ▷ buttons to turn this feature on or off.

Press the ▲/▼ buttons to highlight the time, and press ▷ buttons to adjust the minutes and hours. Set the time you would like the display to automatically power off. Exit to save these settings.

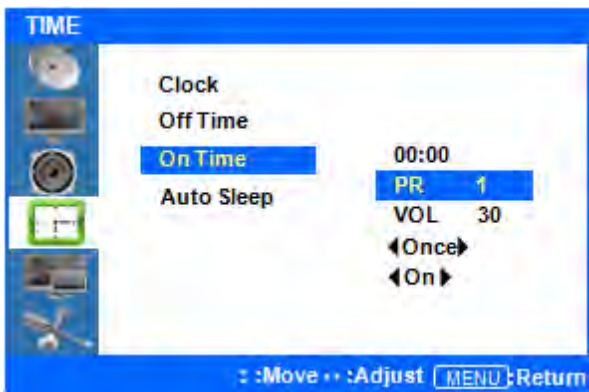

◆ Setup System ON Time

Press ◀ **or the Menu Button** to move or go back to the previous menu options.

Press the ▲/▼ buttons to highlight On Time, and press the OK button to adjust the settings.

Press the ▷ buttons to highlight the time, and press ▷ buttons to adjust the minutes and hours. Set the time you would like the display to automatically power off.

Use the ▲/▼ buttons to highlight VOL and use the ▷ buttons to set the volume level you would like the display to automatically turn on at. The other options allow you to choose how often you want the display to automatically turn on (once/daily). Finally, you can choose to have this feature ON or OFF. Exit to save your settings.

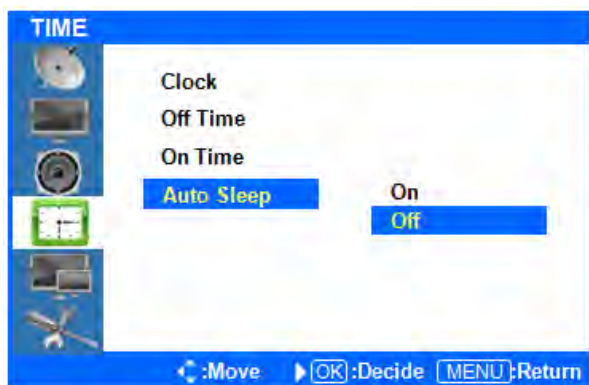

◆ Setup Auto Sleep

If Auto Sleep mode is ON, the screen will go to sleep when no input signal is received and 5 minutes have passed.

Press ◀ **or the Menu Button** to move or go back to the previous menu options.

Press the ▲/▼ buttons to highlight Auto Sleep, and press the OK button to change the settings.

Press the ▷ buttons to select OFF or ON, and press the OK button to select it.

6. Product Specification

Note: Product design and features without prior notice may be changed.

LED PANEL	
Diagonal size	64.56"/ 163.9(cm)
Display Resolution (Max.)	1,920 x 1,080 (FHD)
Brightness (average)	350 cd/m ²
Viewing Angle	H: 176° / V: 176°
Contrast ratio	5000:1 (Typ.)
Supported Colors	16.7M colors (8bit)
Response Time	6.5 ms (GTG)
Display Frame Rate	60Hz (Actual)
Installation	Landscape Orientation
TOUCH	
Detect area	1428.5(H) x 803.5(V) mm / 56.24"(H) x 31.63"(V)
Detection method	Infrared blocking Detection Method
Touch tool	Hand or other solid object(except sharpness)
Accuracy	±2mm
Response time	< 12ms
Available Touch Point	10 Points (Windows) 4 points (Mac with driver software) 1 point (Mac without driver software)
Operating Systems	Windows 7, 8, 10 / MAC 10.10-10.12
PC connector	USB

SIGNAL CONNECTIVITY	
Connector	Display Port x1, HDMI x2(Rear(1.3ver.) x 1, Inside OPS(1.3ver.) x 1), VGA x1
Audio Out	Speaker Out (R/L) , Line out, VGA Audio in
Communication Port	RS-232C (D-sub 9-pin) or LAN(RJ45)
Front Panel	HDMI(1.3ver.) x1, USB-B(for Touch)x1, USB-Ax1
OPS Slot	1
MECHANICAL	
Dimensions Landscape	1506 x 902 x 92 mm
Weight	44.3 kg
VESA mount	400 x 200 (mm), M8 Screw
Front Glass	Tempered Glass 4.0t (Anti-glare Type)
ELECTRICAL	
Power Requirement	100 - 240V AC, 50/60 Hz
Power Consumption	Max. 185W
Power Consumption (Standby)	< 0.5W
Speaker Output	10W + 10W Stereo (8-ohms)
ENVIRONMENTAL	
Operating Temperature	0 ~ 40 °C (32 ~104 °F)
Storage Temperature	- 20 ~ 60 °C (-4 ~ 140 °F)
Operating Humidity	20% to 80% RH (no condensation)
OSD FUNCTIONS	
OSD Language Function	English / Français / Deutsch / Spanish / Portuguese /Italiano / Danish / Swedish / Norwegian / Suomi / Russian / Polish /Turkish / Hungarian / Chesky / Korean
OSD Key Lock Function	Support

* Design and Specifications are subject to change without notice.

7. Product Dimensions

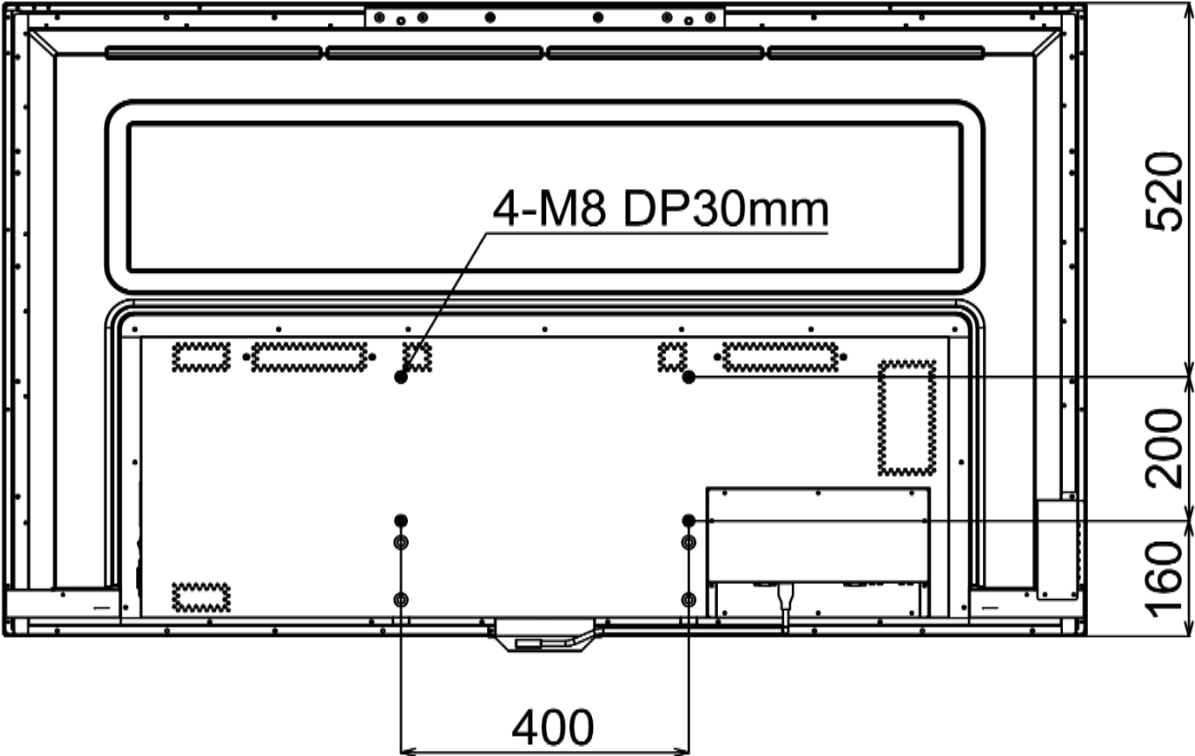
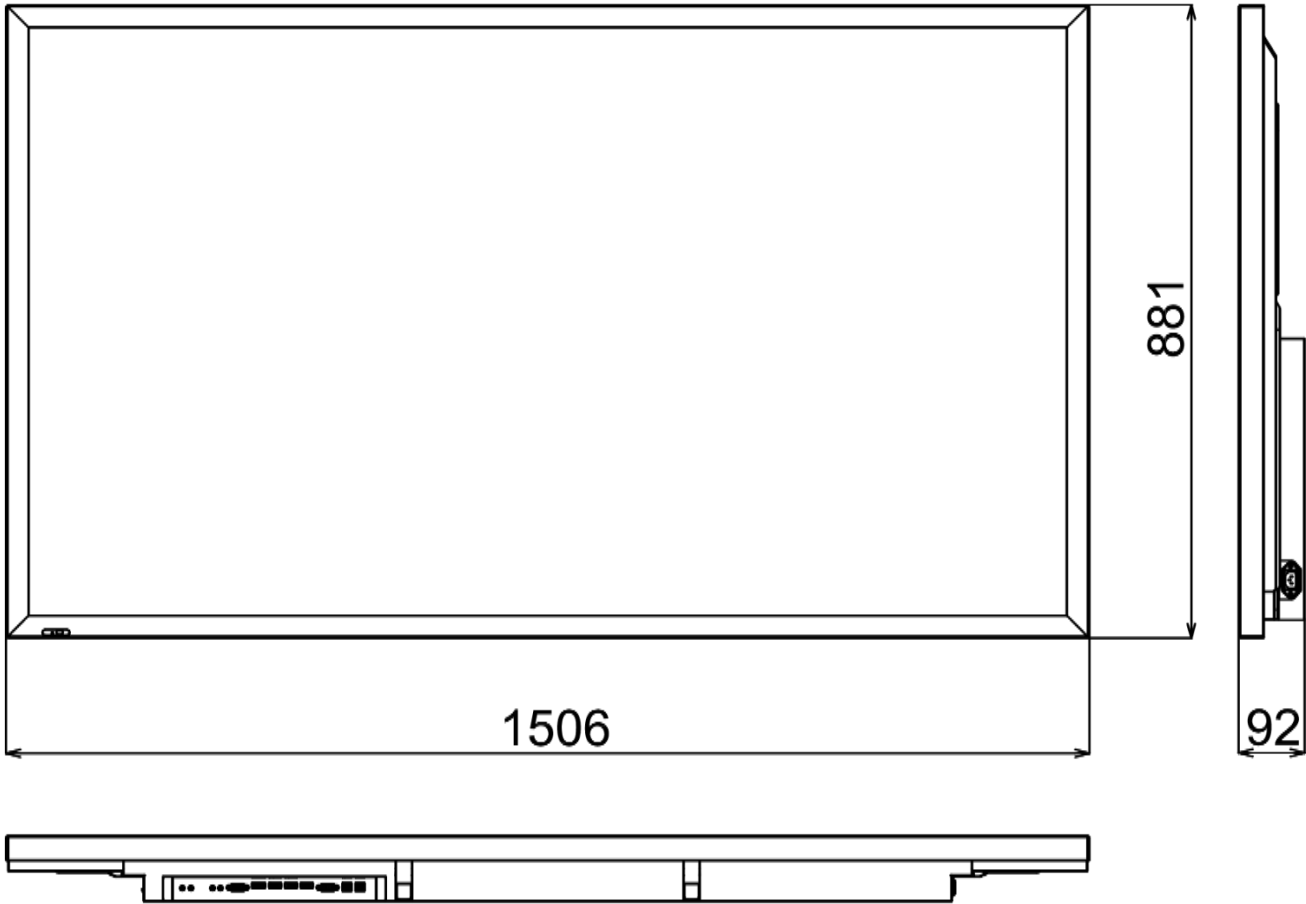

8. Troubleshooting

8-1 Product Self-Diagnosis

- You can check if the product is working properly using the Self-Diagnosis function.
- If a blank screen is displayed but the Power LED on even if the product and the PC are properly connected, perform the self-diagnosis function according to the procedures below.
 - 1) Turn the product and the PC off.
 - 2) Remove the any connected cables from the product.
 - 3) Turn the product on.
 - 4) If the product is working properly, the <No Signal>message appears.
In this case, if a blank screen is displayed again, make sure that there is no problem with the PC and the connection.

8-2. Before Requesting Service

- Please check the following before requesting After-Sales service and if the problem continues, please contact the local dealer where you purchased your product.

1) PROBLEMS RELATED TO SCREEN

- A. Screen is blank and power indicator is off.
 - » Ensure that the power cord is firmly connected and the monitor is on.
- B. “No Signal” Message.
 - » Check the maximum resolution and the frequency of the video adapter.
 - » Compare these values with the data in the Standard Signal Mode Table.
- C. Picture rolls vertically.
 - » Check if the signal cable is securely connected. Connect it again securely.
- D. Image is not clear. Picture is blurred.
 - » Run frequency tuning.
 - » Turn on again after removing all accessories. (Video extension cable, etc.)
 - » Set resolution and frequency to the recommended ranges.
- E. The image is too light or too dark.
 - » Adjust the <Brightness>and<Contrast>and<Backlight>.

2) PROBLEMS RELATED TO AUDIO

- A. No sound.
 - » Ensure that the audio cable is firmly connected to both the audio-in port on your monitor and the audio-out port on your sound card.
- B. The sound level is too low.
 - » Check the volume level. If the volume is still too low after turning the control to its maximum, check the volume control on the computer sound card or software program.

3) PROBLEMS RELATED TO REMOTE CONTROL

A. The remote control buttons do not respond.

- » Check the battery polarities (+/-).
- » Check if the batteries have been exhausted.
- » Check if the power is on.
- » Check if the power cord is securely connected.
- » Check if a special fluorescent or neon lamp is on in the vicinity.

HITACHI
Inspire the Next