

# HITACHI

Inspire the Next

## SPLIT SYSTEM

WALL MOUNTED INVERTER  
AIR CONDITIONERS





# Core Technology INVERTER

*For over thirty five years Hitachi has been dedicated to the development and manufacture of the highest quality air conditioning equipment. In a climate as diverse as ours, you need a range of air conditioners designed to provide superior levels of comfort and reliability – to meet your needs at home and in life.*

*We are changing the shape and quality of people's lifestyles while positioning Hitachi as a cutting edge brand that leads future development as the global air conditioner of choice. Hitachi's 3-Change ethos means your air conditioner has been developed with cleanliness and comfort in mind, supported by Hitachi's own core technologies.*

## POWER SAVING

Inverter technology allows a room to reach the required temperature more rapidly, offering up to 30% more efficiency and also eliminates the stop-start operation used by constant speed systems. Hitachi Inverters adjust (increase/decrease) the speed of the compressor to an energy saving mode in order to maintain the desired temperature.

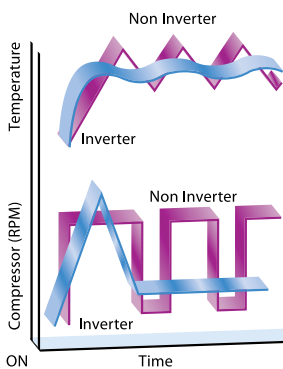

## ALL DC INVERTER

**Energy efficiency.** The "permanent magnet" motor featured in the DC compressor maintains magnetic current without the need for a constant source of electricity. This ensures the motor suffers less ambient energy loss, delivering 10% greater efficiency than equivalent AC inverters.

### Compact design.

The DC system is designed so all transformers and relays are located in the outdoor unit which performs the AC-DC conversion. The result is a compact, stylish and quiet indoor unit.

**Installation safety.** Utilising a low DC current of only 35V ensures absolute safety during the installation process.

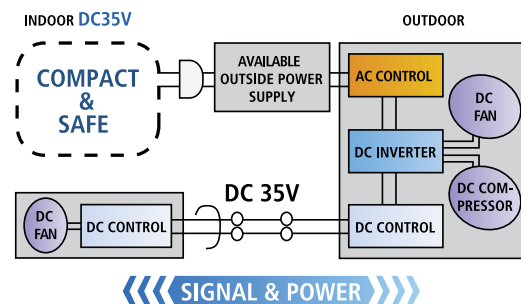

Hitachi All DC Inverter

## PAM SYSTEM

The Hitachi Power Active Model (PAM) Inverter System suppresses electrical distortion to minimise power losses to less than 1%. Heating performance is particularly improved to ensure efficient performance even when the ambient temperature is -15°C.

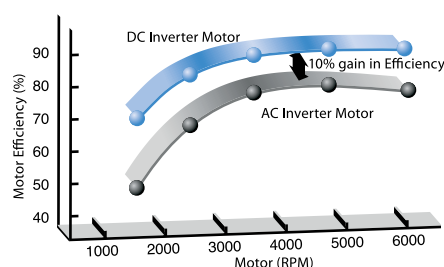

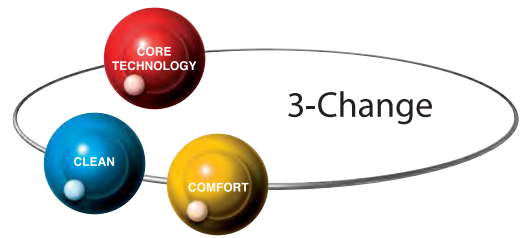

### INVERTERTWIN ROTARY COMPRESSOR

Hitachi Inverter Air Conditioners feature twin rotary compressors. This ensures a well balanced, smoother rotation which minimises noise and improves efficiency.

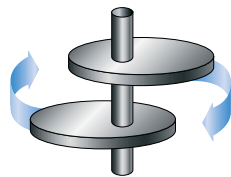

### FULL FLAT PANEL

The innovative new "Full Flat" design creates one of the most efficient yet ultra-quiet air conditioning ranges available. The intelligent, compact panel draws air through the top of the unit and diagonally across the heat exchanger, this combined with the simple yet highly efficient conical shape fan, using tangential blade design, means that air is carried through the panel faster, covering a wider area and in near silence.



### AUTO RESTART

Hitachi air conditioners are able to memorise the precise operation mode, air flow, temperature and timing settings. In the event of a power failure, settings will automatically reset to the original operating mode once power is restored.

### LAMBDA HEAT EXCHANGER

This clever control feature automatically provides optimal cooling or heating operation by using a combination of indoor/ outdoor sensors and room temperature settings. To adjust the room temperature quickly and efficiently, the advanced design allows for a wider air inlet path across the heat exchanger.

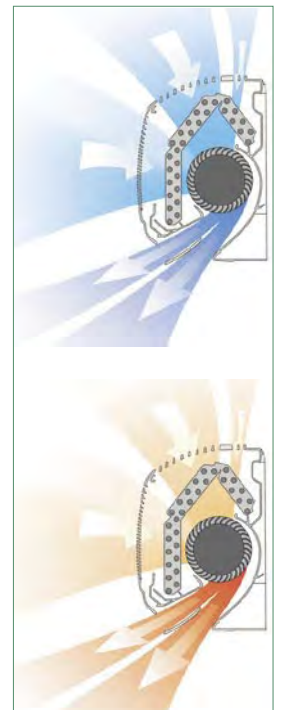

\* Features may vary by model. Please check specifications table.



# Clean AIR FOCUS

## AIR PURIFYING NANO-TITANIUM FILTER AND ANTI-BACTERIAL FAN

The Nano-Titanium filter and the conical blade fan features in Hitachi air conditioners are designed to substantially reduce bacteria, prevent mould growth and deodorise the air distributed by your air conditioner.

The Nano-Titanium agent, is smaller in size and denser than conventional anti-bacterial agents, trapping and preventing up to 99.9% of bacterial particles from travelling through the filter.

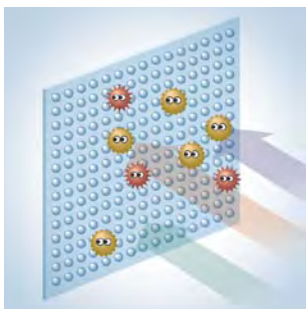

Nano-Titanium filter

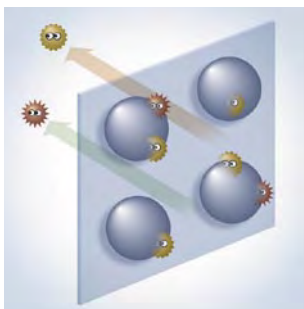

Conventional filter

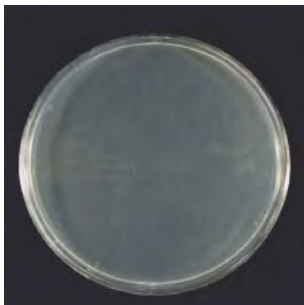

## UV FILTRATION SYSTEM

Homes are often contaminated with invisible airborne microbes such as bacteria, viruses, fungi and dust mites. Ultraviolet light, as found in sunlight, is one of nature's most effective sanitising agents and has been used in hospitals, supermarkets and restaurants for many years.

Hitachi air conditioners now feature the same clever technology. The durable LED used ensures you have up to 10 years of cleaner, healthier living.

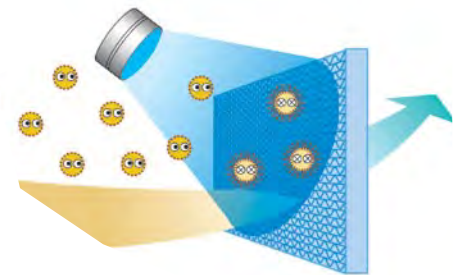

## NEGATIVE ION STICK

The Negative Ion Stick works in conjunction with static charged filters to trap particles and provide you with cleaner air. Positioned in front of the static charged filter, Hitachi's Negative Ion Stick powerfully attracts airborne particles, drawing more particles directly into the filter.

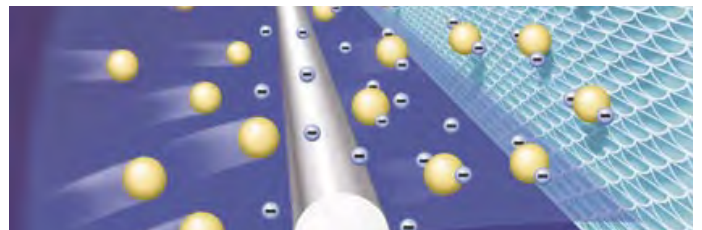

## EFFICIENT AIR DISTRIBUTION

The improved design of the directional air flow flap minimises air resistance to distribute a greater volume of air into the room to quickly and efficiently adjust the room temperature.



# Comfort

## MULTI-DIRECTIONAL AIRFLOW

Selected Hitachi models also incorporate a two-way air flow system for more efficient air distribution.

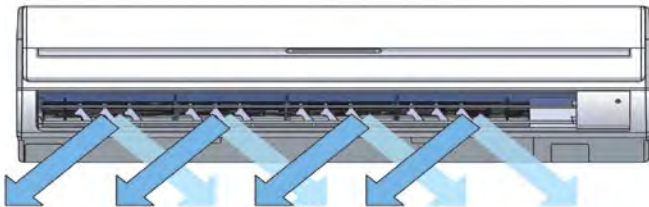

## REFRIGERANT – R410A

The new range of Hitachi inverters feature the refrigerant R410A. While achieving the same energy efficiency of previous refrigerant gases, R410A is non-toxic, non-flammable with zero ozone depletion.



## EASY TO CLEAN

The front panel on all Hitachi air conditioning units can be cleaned with a single wipe or detached for a complete wash



## LOW STARTING CURRENT

Hitachi DC Inverter technology uses a low starting current, which minimises the 'flickering' of your house lights when the air conditioning unit starts up.

## ANTI-CORROSION COATING

The special anti-corrosion coating on the outdoor heat exchanger improves durability.



Green anti-corrosion coating pictured.

## LCD REMOTE CONTROL

The handy infrared remote control allows you to accurately select the desired room temperature from the comfort of your armchair. All commands are shown clearly on the liquid crystal display. A smart system of one touch buttons can create the perfect environment with ease.



## INVERTER SPLIT SYSTEMS 5 YEAR WARRANTY

The five year warranty on parts and labour is your guarantee of the finest quality and customer support.<sup>†</sup>



## INVERTER MODELS

RAS25YHA1 – 2.5/3.5 kW



RAS35YHA1 – 3.5/4.2kW



RAS50YHA1 – 5.0/6.1kW



RAS60YHA1 – 6.0/7.3kW



RAS70YHA1 – 7.0/8.3kW



RAS80YHA1 – 8.0/9.3kW



<sup>†</sup> Five (5) years domestic application. One (1) year commercial application unless otherwise noted by Hitachi Australia Pty Ltd. Excluding process cooling such as: computer rooms and industrial applications. Terms and conditions apply to all warranties.

## SPECIFICATIONS

### Outdoor Unit (Typical example shown)



### Indoor Range



RAS 25/35 YHA1



RAS 50/60 YHA1



RAS 70/80 YHA1

### MEPS II

DC Inverter systems are designed for efficiency and are compliant to MEPS II standards.

*Specifications are subject to change with product improvement and without notification. It remains the contractor's responsibility to determine that the power supply is in accordance with the above specifications and all local electrical codes and authorities.*

**Specification details provided in this brochure are indicative only. Please refer to the Hitachi Design and Installation manuals for all technical information.**

HIT 3202 SOPP 10/07

Model Name	Indoor Unit	
	Outdoor Unit	
Capacity	Cooling - Rated (Min - Max)	kW
	Heating - Rated (Min - Max)	kW
Power Input (240.1.50) (Connect to Outdoor Unit)	Cooling - Rated (Min - Max)	W
	Heating - Rated (Min - Max)	W
EER/COP	Cool/Heat	
Star Rating	Cool/Heat	
Airflow - Indoor	Cool Mode (H,M,L)	l/s
	Heat Mode (H,M,L)	l/s
Moisture Removal		l/hr
Sound Pressure Indoor @ 1mtr	Cool Mode (H,M,L,Sleep)	dB(A)
	Heat Mode (H,M,L,Sleep)	dB(A)
Sound Pressure Outdoor @ 1mtr	Cool/Heat	dB(A)
Sound Power Outdoor		dB(A)
Weight (Net)	Indoor/Outdoor	kg
Dimensions (H x W x D)	Indoor	mm
	Outdoor	mm
Max Pipe Run	Max Length/Height	mtr
Refrigerant (R410A)	Pre-charged Length	mtr
	Additional Charge	g/mtr
Compressor	Type	
Outdoor Operating Range	Cooling	°C
	Heating	°C
Pipe Size	Liquid ( Flared Connection)	mm
	Gas (Flared Connection)	mm
Electrical	Starting Current	amps
	Run Current (Cool/Heat)	amps
<b>FEATURES - Note: Features and technical specifications indicative only</b>		
Nano Titanium Filter		
UV Filter		
Negative Ion Stick		
Anti Corrosion (O/U Coil)		
Indoor Fan – Anti Bacterial Coating		
Multi-Directional Air Flow		
PAM Control		
All DC Control Indoor/Outdoor		

## INVERTER SPLIT SYSTEM REVERSE CYCLE - Note: Features and technical specifications indicative only

RAS25YHA1	RAS35YHA1	RAS50YHA1	RAS60YHA1	RAS70YHA1	RAS80YHA1
RAC25YHA1	RAC35YHA1	RAC50YHA1	RAC60YHA1	RAC70YHA1	RAC80YHA1
2.5 (0.9-3.1) <sup>1</sup>	3.5 (0.9-4.0) <sup>1</sup>	5.0 (0.9-5.8) <sup>1</sup>	6.0 (0.9-6.8) <sup>1</sup>	7.0 (0.9-8.3) <sup>1</sup>	8.0 (1.5-8.5) <sup>1</sup>
3.5 (0.9-4.4) <sup>1</sup>	4.2 (0.9-5.0) <sup>1</sup>	6.1 (0.9-6.8) <sup>1</sup>	7.3 (0.9-7.8) <sup>1</sup>	8.3 (1.5-9.7) <sup>1</sup>	9.3 (1.5-9.7) <sup>1</sup>
700 (155-1290)	1090 (155-1460)	1550 (155-2000)	1840 (155-2200)	2210 (200-2820)	2650 (200-2950)
880 (155-1250)	1110 (155-1440)	1730 (155-2200)	2200 (155-2600)	2500 (200-2970)	3000 (200-3250)
3.6/3.9	3.2/3.8	3.2/3.5	3.3/3.3	3.2/3.3	3.1/3.1
6.0/6.0	4.5/5.0	5.0/5.0	4.5/4.0	4.5/4.0	4.5/3.5
142/117/100	167/133/108	225/208/188	258/225/208	292/258/200	317/275/225
158/133/117	180/142/125	237/221/200	270/237/221	310/267/228	329/284/239
1.4	1.6	2.8	2.8	4.8	5.2
38 32 26 20	42 35 29 25	47 39 28 24	49 41 32 29	47 42 33 30	48 43 40 36
39 33 27 23	42 35 30 26	47 39 31 27	49 39 32 29	46 42 33 30	47 44 41 38
46/48	46/49	50/52	50/51	51/52	55/55
61	63	63	63	68	68
9.5/27	9.5/27	9.5/35	12/52	15/52	15/52
280/780/220	280/780/220	295/1030/191	295/1030/191	333/1150/245	333/1150/245
505/700/258	548/750/288	650/850/298	800/850/298	800/850/298	800/850/298
20/10	20/10	20/10	30/10	30/10	30/10
20	20	20	20	20	20
0	0	0	5	10	20
ROTARY	ROTARY	TWIN ROTARY	TWIN ROTARY	TWIN ROTARY	TWIN ROTARY
43/-10	43/-10	43/-10	43/-10	43/-10	43/-10
21/-15	21/-15	21/-15	21/-15	21/-15	21/-15
6.35 (1/4)	6.35 (1/4)	6.35 (1/4)	6.35 (1/4)	6.35 (1/4)	6.35 (1/4)
9.5 (3/8)	9.5 (3/8)	12.7 (1/2)	12.7 (1/2)	15.9 (5/8)	15.9 (5/8)
4.1	4.9	8.3	9.8	11.8	12.5
3.3/4.1	4.8/4.9	6.5/7.3	7.7/9.3	9.3/10.5	11.2/12.6
YES	YES	YES	YES	YES	YES
–	–	YES	YES	YES	YES
YES	YES	–	–	YES	YES
YES (Transparent)	YES (Transparent)	YES (Green)	YES (Green)	YES (Green)	YES (Green)
YES	YES	YES	YES	YES	YES
–	–	–	–	YES	YES
–	–	YES	YES	YES	YES
YES	YES	YES	YES	YES	YES

NOTES: 1: Nominal inverter operation range denoted in brackets. Units tested under ISO 5151 (for capacity) and EEC 60335-2-40 (for safety).  
 COOLING, Indoor: Rated at 27°C DB/19.0°C WB entering air. Ambient: Rated at 35°C DB. HEATING, Indoor: Rated at 20°C DB entering air.  
 Ambient: Rated at 7°C DB/ 6°C WB. Mains power source AC240V 50Hz.

## SPLIT SYSTEM AIR CONDITIONERS



# HITACHI

Inspire the Next



DISTRIBUTED BY



**Head Office:**  
**NSW/ACT/WA**

Level 3,  
82 Waterloo Rd,  
Macquarie Park,  
NSW 2113  
Ph: +61 2 9888 4100  
Fax: +61 2 9888 4195

**QLD**

Unit 12, Northport  
Industrial Park,  
441 Nudgee Rd, Hendra,  
QLD 4011  
Ph: +61 7 3868 6114  
Fax: +61 7 3630 1826

**VIC/TAS/SA**

Level 12,  
600 St Kilda Rd,  
Melbourne,  
VIC 3004  
Ph: +61 3 8866 1420  
Fax: +61 3 8866 1499

For all air conditioning sales and products enquires contact:

**1800 032 689 - Dial 1 and follow the prompts.**

Hitachi Australia Pty Ltd (ABN 34 075 381 332) [www.hitachi.com.au](http://www.hitachi.com.au)

Hitachi is a registered trademark of Hitachi Limited. Specification details provided in this brochure are indicative only. Please refer to Hitachi Design and Installation manuals for information.