

Installation Manual



Model: HILS75204/HILU75203
Interactive Flat Panel Display

QUICK SETUP GUIDE

For further information, see the user manual.

Please contact directly if you have questions on the use of the touch monitor after reading the Installation Manual and User Manual.

IMPORTANT:

Please read the precautions, safety instructions and this installation manual carefully before installing the touch monitor.

CAUTION:

Changes or modifications not expressly approved by the party responsible for compliance with the FCC Rules could void the user's authority to operate this equipment.

1. Precautions and safety instructions

Before using the touch monitor, please read this quick setup guide thoroughly to help protect against damage to your own and other people's property and ensure your own and other people's personal safety.

Be sure to observe the following instructions.

For your safety, be sure to observe the warnings contained in this guide.

For installation or adjustment, please follow this quick setup guide and refer all servicing to qualified service personnel.

Safety Precautions

If smoke or a peculiar smell comes from the monitor, remove the power plug from the socket immediately.

Failure to do above, it may result in an electric shock.

Contact your dealer for inspection.

If the monitor has been turned on but there isn't a picture, remove the power plug from the socket immediately. Failure to do above, it may result in an electric shock.

Contact your dealer for inspection.

If water is spilled or objects are dropped inside the monitor, remove the power plug from the socket immediately.

Failure to do above, it may result in an electric shock.

Contact your dealer for inspection.

If the monitor is dropped or the cabinet is damaged, remove the power plug from the socket immediately.

Failure to do above, it may result in an electric shock.

Contact your dealer for inspection.

To turn off the power of the monitor completely, remove the power plug from the socket

If the power cord or plug is damaged or becomes hot, turn off the main power switch of the monitor, make sure the plug has cooled down and remove the plug from the socket. If the monitor is still used in this condition, it may cause an electric shock.

Contact your dealer for replacement.

Moving and Carrying Notice

Moving Notice:

Moving the monitor requires at least four people. If not, it may drop and a serious injury may result.



Carrying Notice:

This monitor is heavy; please follow the instructions below when you are ready to carry the monitor. Failure to do, it may cause injury.

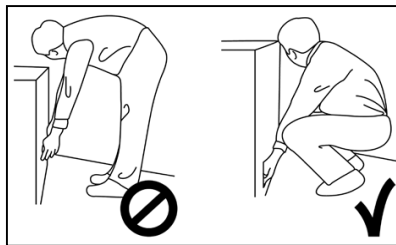

Installation

Don't install in a high-temperature environment.

If the monitor is used in a high-temperature environment or in direct sunlight, it may cause the case or other parts to become distorted or damaged resulting in overheating or electric shock. Don't install in a high-humidity environment. This may cause overheating or electric shock.

Don't install near any heat sources such as radiators, hot-air outlets, stoves, or other apparatus that produce heat. This may cause an electric shock.

Don't overload sockets or cables beyond electrical capacity. Don't use extension leads, otherwise this may cause an electric shock.

Don't insert the power plug into a socket other than 100~240V AC.

This may cause an electric shock.

- Don't use a damaged power plug or worn socket.
- Don't insert the wrong plug as it may cause an electric shock.

Do not place monitors on unstable shelves or surfaces. They could collapse and cause damage. Only install the unit on vertical, stable and level surfaces.

Don't place objects on the touch monitor.

- If the touch monitor is covered or the vents are blocked, the monitor could overheat and cause a fire.
- If metal or liquid gets into the monitor, it may cause an electric shock.
- Do not place heavy objects on the monitor as they may fall causing injury.
- Please keep a minimum distance of 10 cm between the monitor and the other objects for sufficient ventilation.

Don't move the touch monitor when it is connected to the power cord and AV cables.

- When moving the monitor, make sure you remove the plug and cables from the socket or source.
- When unpacking or carrying the monitor, at least 4 people are needed. Make sure the monitor is carried upright.
- Transport the monitor upright. Avoid placing the monitor face up or face down.
- Handle the monitor gently. Do not drop.

Wall mounting safety notes

Please make sure the bracket is fixed to a solid wall.

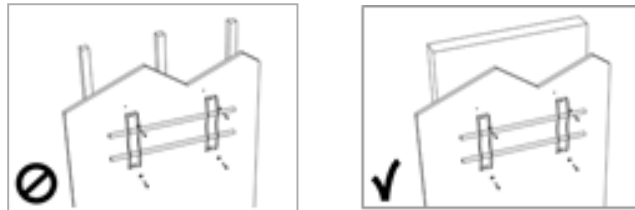

After assembling, please don't pull or shake violently.

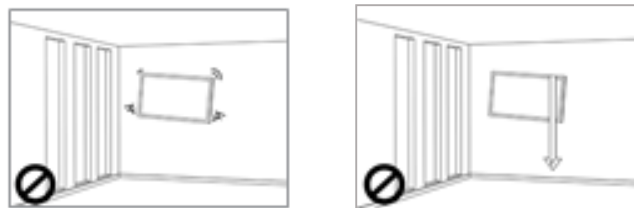

Please don't install the bracket in direct sunlight or areas of humidity / high temperature for fear that the quality is affected

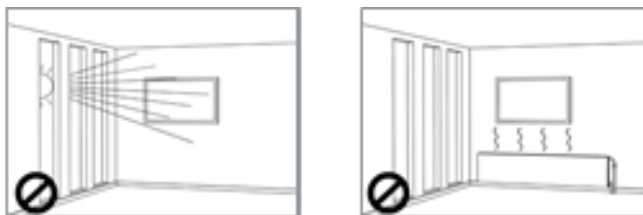

Install the bracket at a minimum distance of 10 cm from other objects / walls on either side. Only attach to vertical walls.



2. Package contents

Packing list

Item	Q'ty
1. Interactive monitor	1
2. Carton	1
3. Bottom cushion	2
4. Top cushion	3
5. Packing bag	1
6. Accessories box	1

Unpacking

1. Set the LCD Monitor box in front and upright position.
2. Cut the banding and take off 10 clips
3. Open from the top of the box before removing the top cushions.
4. Remove the top cushion and take the accessories box out.
5. Take vinyl bag off and assembled bracket if it needs

Contents of the Accessories box

1. Power cord
2. Remote controller (2x AAA batteries included)
3. USB cable
4. HDMI cable
5. Pen x2
6. CD
7. Pentray

※ Note

The following features are considered with the requirements:

- The equipment is intended to be installed on wall but any mounting means are not provided with the equipment. For the installation, the following statement and caution described in user manual;
- Ensure that an authorized installation company installs the wall mount(This monitor shall be installed by qualified service personnel only).
- Otherwise, in may fall and cause personal injury.
- Wall mount have to be dimensioned according to size and weight of the monitor and according to the instructions of wall mounting device.

3. Description



① LED Indicator

- Power ON mode: BLUE
- Power OFF(Standby) mode: RED
- Be sure to point the remote control at the remote control sensor on the LED/LCD Display.

② USB for OPS and external devices.

③ Touch USB : USB Port is available when External Source is selected.

④ HDMI Input (When connected, it changes to External Source.)

Important Notice

- ◆ The USB cable (3m) that Hitachi provides in this accessory box is for the Touch USB at the back. Therefore, in case of connecting USB cable to Touch USB port in front, separate USB cable is required and the length of cable is strongly recommended to be less than 3m to make sure the signal intensity of touch sensor works properly.

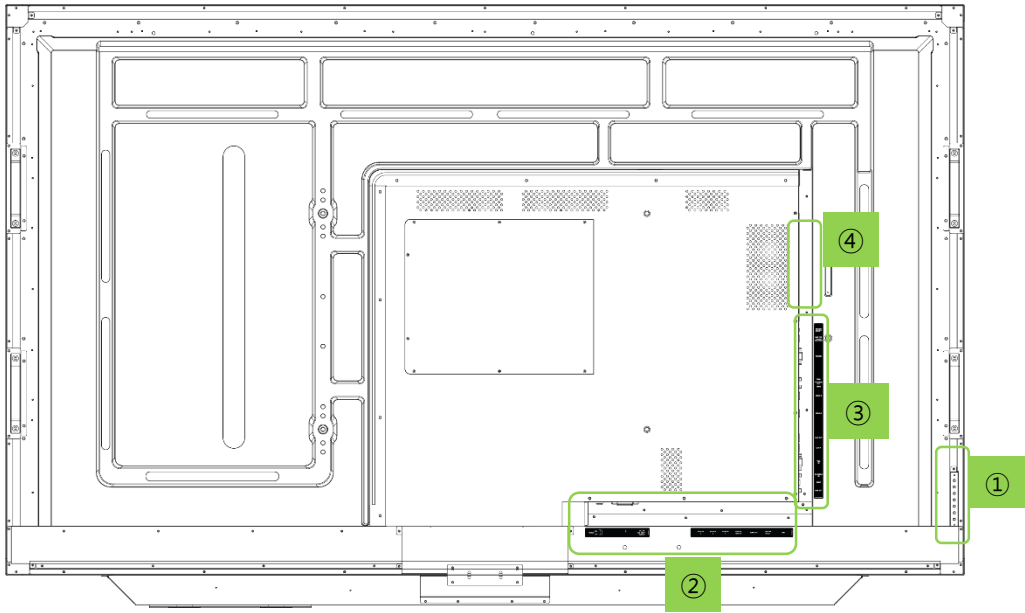

① Button Control

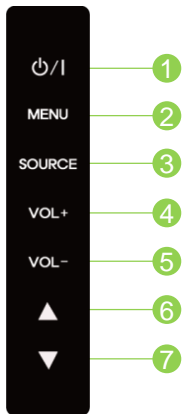

1	ON / OFF
2	Display the main screen menu
3	VGA, OPS, EXTERNAL, HDMI 1, HDMI 2, HDMI 3, DP
4	Volume Up (Right)
5	Volume Down (Left)
6	Move Up
7	Move Down

② Rear Panel Connections

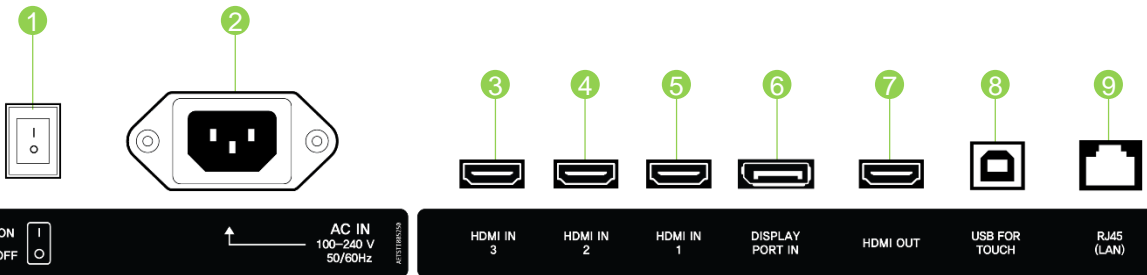

1	Power Switch : ON / OFF
2	AC IN : 100V~ 240V, 50/60Hz
3	HDMI 3 Input
4	HDMI 2 Input
5	HDMI 1 Input

6	Display Port
7	HDMI Output
8	USB For Touch
9	RJ45(LAN)

Note: HDMI 1 has separate USB for Touch located on ③

③ Rear Panel Connections

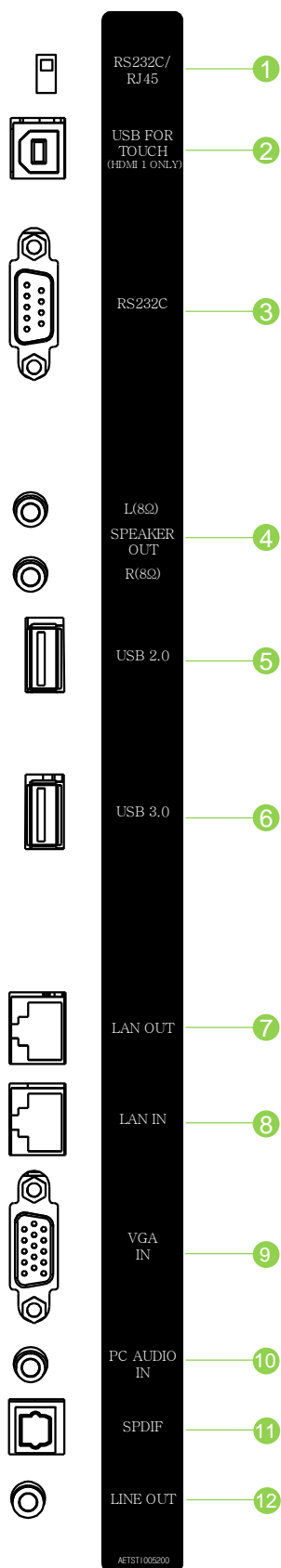

1	RS232/RJ45 SWITCH
2	USB FOR TOUCH HDMI1 ONLY
3	RS232C
4	SPEAKER OUT
5	USB 2.0 (Supports USB cam or camera function)
6	USB 3.0 (Supports USB cam or camera function)
7	LAN OUT
8	LAN IN
9	PC RGB IN
10	PC AUDIO IN
11	SPDIF
12	LINE OUT

④ Installing an OPS PC

There is a slot on ④ for OPS PC. When you need to install an OPS PC, remove screws and existing cover first and screw up again after mounting OPS PC in the slot.

⑤ AC cord holder

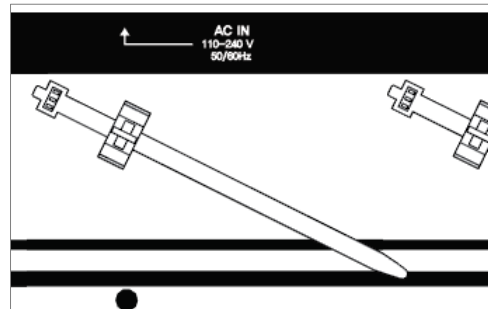
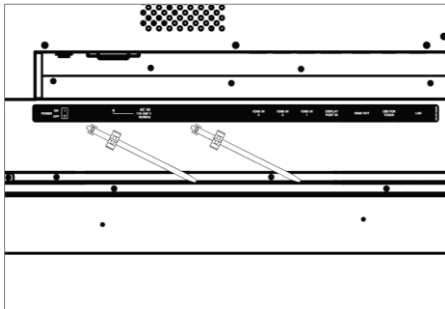

- To prevent the power cable from falling/shaking, you may use the cable holder if necessary. SCREW (4x11)

4. Remote Controller(RCU) Instructions



Key Name	Description
⏻/⏻	Power ON/OFF.
SOURCE	Activates OSD menu of input source selecting. Navigates input source downwards.
▲	Navigates upper menu in main OSD menu. Navigates input source.
▼	Navigates down menu in main OSD menu. Navigates input source
▶	Navigates to next menu in main OSD menu.
◀	Navigates to previous menu in main OSD menu.
OK	Select the highlighted menu option.
MENU	Activates main OSD menu.
EXIT	Closes main OSD menu.
FREEZE	Allows you to capture and freeze an image from a moving image that you are watching.
VOL+	Volume UP
VOL-	Volume Down
MUTE	Toggles sound status of speaker.

**How to insert battery

Insert the battery into proper polarities
Battery model: Battery 1.5V(AAA)

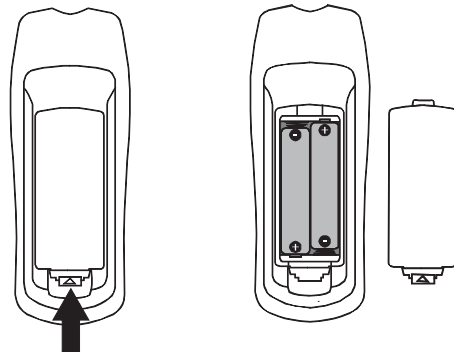

Battery Precautions

These precautions should be followed when using batteries in this device:

- The batteries may last approximately one year depending on how much the remote control is used. Replace batteries when the remote operation becomes erratic.
- Use only the size and type of batteries specified.
- Be sure to follow the correct polarity when installing the batteries as indicated in the battery compartment. Reversed batteries may cause damage to the device.
- Do not mix different types together (e.g. Alkaline, Carbon-zinc or Rechargeable) or old batteries with fresh ones.
- If the device is not to be used for a long period of time, remove the batteries to prevent damage or injury from possible battery leakage.
- Do not try to recharge batteries not intended to be recharged; they can overheat and rupture. (Follow battery manufacturer's directions.)
- Please use caution when inserting batteries to avoid battery damage. If the spring terminal in the remote control remains in contact with a side of a damaged battery it can cause a short circuit. Never use damaged batteries as they can become very hot and are dangerous.
- Never expose batteries(battery pack or batteries installed) to excessive heat such as sunshine, fire or the like.

Display Mode

Turning the monitor on

1. Correctly insert the power cord into the monitor and into the power socket.
2. Press the power button on the bottom of monitor or front control panel.

Turning the monitor off

With the power on, press the power button on the remote or control keypad to place the monitor backside in a standby mode. To turn off power completely, disconnect the AC power cord or turn power switch off.

Selecting the input source

1. Using the remote, press SOURCE on the monitor backside keypad and toggle the source button until you have reached the desired source, and press ENTER (VGA, OPS, HDMI 2, HDMI 1, DP)
2. If the monitor cannot find a source, a "No signal" message will be appeared.

5. Touch Operation

No calibration is required first-time use. However, the touch system might need calibration over time or when for instance a different resolution is used. Please find calibration instructions below for the different operating systems:

Installation

1. Connect the signal cable to the monitor and then turn on the monitor.
2. Connect one side of the USB cable (type-B USB connector) on the monitor side. (See “chapter 3, Signal Source Input” for exact location)
3. Connect the other side of the USB cable (type-A USB connector) to the computer.
4. Turn the computer on.

Windows 7, 8, 10 and Mac OSX (Version 10.10 ~ 10.12)

Window System: No need to install the driver and calibration, but if need to detail calibration or improve performance, please install the driver.

MAC System: (Should be install the driver, if not, touch function is not working)

Windows 7, 8, 10 and Mac OSX Calibration Procedure

1. Install and run the “Touch Win Setup” configuration program on the computer.
2. Press “Calibration”.
3. A black screen with one green and eight white calibration points appears.
4. Tap the green calibration point with your finger or Ergonomic Stylus shortly.
5. The cursor will move to the next calibration point. Repeat action 4 and move on to the next indicated calibration point.
6. Repeat action 4 until you get to the last calibration point in the lower right-hand corner.
7. When you complete the nine-point calibration, a conformation window appears. Click done to accept the calibration; click Cancel or do nothing (in which case the calibration window automatically disappears after five seconds) to cancel the calibration.
8. The front B-type USB is for laptop touch. An USB is automatically connected when you connect a laptop. The rear B-type USB is for PC. An USB is automatically connected to laptop when you connect a laptop and PC at the same time. Remove the laptop USB if you want to use a PC.

6. Wall Mounting

VESA mount size: 600(W) x 400(H) mm

Separate wall mount screw and pipe from Monitor.

As shown below, wall mount bracket is assembled with screw and pipe. Pipe only use the upper left and right and fixing screw is assembled attention to the screw length.

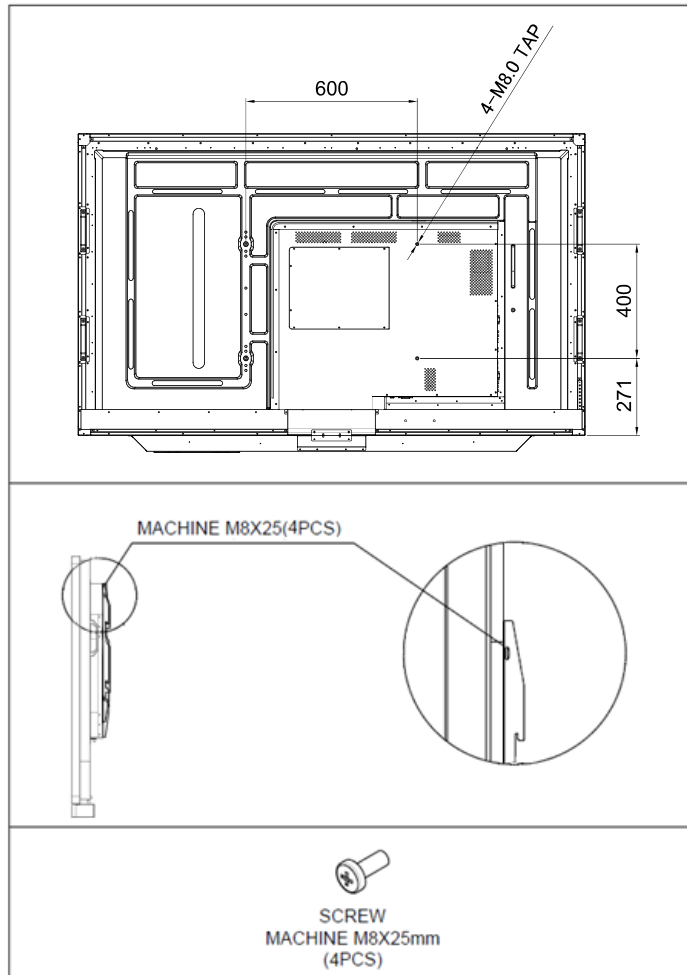

7. Trouble Shooting

VESA mount size: 600(W) x 400(H) mm

Before calling service personnel, please check the following chart for a possible cause to the trouble you are experiencing.

Perform the adjustments according to the instructions on the “Operating the monitor page”. If the problem you have experienced isn’t described below or you can’t correct the problem, stop using the monitor and call service personnel or your dealer.

Problem	Check these things
No Display	Ensure the power plug is installed correctly at both ends. Make sure the signal cable is installed correctly at both ends. Check that source equipment is operating correctly. Check if the input signal is compatible with this display.
The image is not centered	Check if the input signal is compatible with this display.
The image is not locked correctly	Check if the input signal is compatible with this display
If the remote control doesn't work, make sure the batteries are new and installed correctly.	Ensure the remote is aimed at the IR sensor on the front of the display
The picture color looks poor	Check the picture settings and reset the display

8. Compliance and regulatory information

FCC Compliance Statement:

This equipment has been tested and found to comply with the limits for a Class A digital device, pursuant to part 15 of the FCC Rules. These limits are designed to provide reasonable protection against harmful interference when the equipment is operated in a commercial environment. This equipment generates, uses and can radiate radio frequency energy and, if not installed and used in accordance with the quick setup guide and user manual, may cause harmful interference to radio communications. Operation of this equipment in a residential area is likely to cause harmful interference in which case the user will be required to correct the interference at their own expense.

Warning

This is a Class A product. In a domestic environment this product may cause radio interference in which case the user may be required to take adequate measures.

This device complies with Part 15 of the FCC Rules.

Operation is subject to the following two conditions :

- 1) this device may not cause harmful interference, and
- 2) this device must accept any interference received, including interference that may cause undesired operation



