

SPECIFICATIONS

| Model name | CP-A300N/CP-A300NM | CP-A220N/CP-A220NM |
|---------------------------|---|--|
| Liquid crystal panel | 0.63 type (inch), 1.6cm polysilicon active-matrix TFT x 3 | |
| Number of pixels | 786,432 pixels (H1024 x V768) | |
| Resolution | 1024 x 768 color pixels (XGA) | |
| Digital zoom | x1.2 | |
| Lamp | 210W UHP | |
| Light output (brightness) | 3,000 Lumens | 2,200 Lumens |
| Contrast ratio | 2,000:1 (Presentation mode) | |
| Audio | 10W | |
| Keystone correction | Manual Horizontal/Vertical Keystone | |
| Power supply | AC100-120V/AC220-240V | |
| Operating temperature | 5-35°C (41-95°F) | |
| Input signals | Computer input: VGA, SVGA, XGA, WXGA, WXGA+, SXGA, SXGA+, UXGA, MAC16+ Video input: NTSC, NTSC4.43, PAL, SECAM, M-PAL, N-PAL, PAL (60Hz) HDTV: 720p@60, 1080i@50/60, 1080p@50/60 SDTV: 480i, 480p, 576i | |
| Input/output terminals | Video input: S-Video: Mini Din 4-pin x 1, Composite video: RCA jack x 1 Component video: via Mini-Dsub x 2 Audio input: Stereo Mini jack x 2, RCA jack x 2 (L/R) Computer input: Analog RGB: 15-pin Mini-Dsub x 2 HDMI input: HDMI x 1 (HDCP compliant) Audio output: RCA jack x 2 (L/R) Monitor output: Analog RGB: 15-pin Mini-Dsub x 1 USB: USB type A x 1 for PC-less presentation, USB type B x 1 for USB display, USB mouse control Control: 9-pin Dsub x 1 for RS232C Wired network (LAN): RJ-45 x 1 Mic. input: Mono Mini jack x 1 (compatible with dynamic microphones and unbalanced signal lines) | |
| Agency certifications | UL/cUL, FCC Part15 class A, AS/NZS CISPR22 class A, CE, RoHS, GOST-R | UL/cUL, FCC Part15 class A, AS/NZS CISPR22 class A, CE, RoHS |
| Dimensions (WxHxD) | 345 x 85 x 303mm (13.6" x 3.3" x 11.9") [excluding protruding part, when mirror is closed.] | |
| Weight | Approximately 3.8kg (8.5 lbs.) | |
| Standard accessories | Computer cable, Remote control (Part#: HL02772), Batteries, Cable cover, Power cord, User's manual, Security label, Application CD, Wall mount unit and user's manual* Cable cover: [Image] Wall mount unit (HAS-K250)*: [Image] *Optional with CP-A300N/CP-A220N. | |
| Optional accessories | Lamp: DT01181, Filter set: UX37191, Laser remote control: HL02651 (RC-R008) | |

TERMINALS

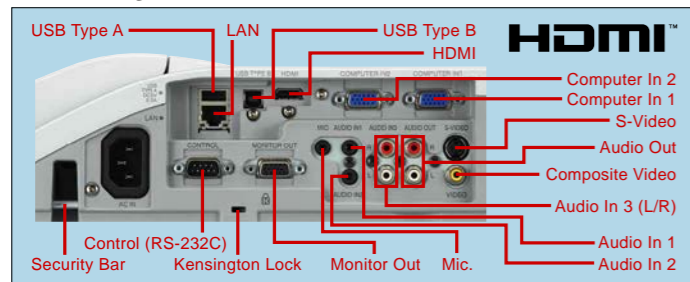

DIMENSIONS

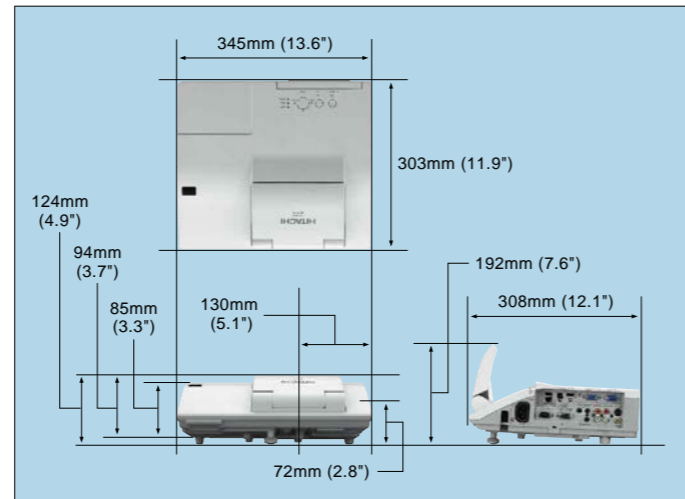

PROJECTION DISTANCE

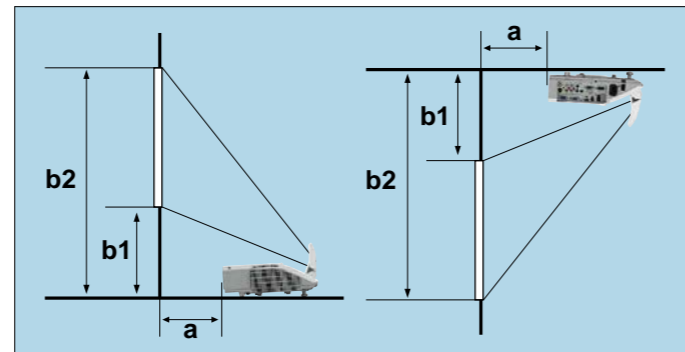

| Screen Size (4:3 Screen) | a | b1 | b2 |
|--------------------------|----------------|----------------|----------------|
| 60 type (inch), 1.5m | 0.096m (3.8") | 0.281m (11.1") | 1.196m (47.1") |
| 70 type (inch), 1.8m | 0.161m (6.3") | 0.317m (12.5") | 1.384m (54.5") |
| 80 type (inch), 2.0m | 0.225m (8.9") | 0.352m (13.9") | 1.571m (61.9") |
| 90 type (inch), 2.3m | 0.289m (11.4") | 0.387m (15.2") | 1.759m (69.2") |
| 100 type (inch), 2.5m | 0.353m (13.9") | 0.423m (16.6") | 1.947m (76.6") |

* Manufacturer's recommended size is 60 type (inch), 1.5m - 100 type (inch), 2.5m. • Tolerance ±8% (for projection distance a) • Final specifications may vary slightly.

Consideration for the Environment

Compliance with EU Directive RoHS*1

*1 RoHS is the acronym of "DIRECTIVE 2002/95/EC OF THE EUROPEAN PARLIAMENT AND OF THE COUNCIL of 27 January 2003 on the restriction of the use of certain hazardous substances in electrical and electronic equipment".

Reduction of resin usage in production

Use of hot runners in molds for making upper housing in order to reduce mill ends.

Reduction of CO2 emissions

Carton volume has been cut down to 43%*2, reducing CO2 emissions during transport.

*2 Compared to Hitachi CP-A100 ultra-short throw projector on the basis of one carton box.

Power saving mode engaged during standby

ECO mode

ECO mode provides power saving.

- Design and specifications are subject to change without notice.
- The projected images and comparison photos in this catalog are simulations.
- LCD panels, polarizers and other optical components and cooling fans may need replacement after prolonged usage. For more details, please consult a Hitachi sales representative.
- Do not use in places where there is a lot of water, dampness, steam, dust, soot or tobacco smoke. This may result in fire or malfunction.
- Optical components (lamp, LCD panel, polarizing plate, PBS [polarizer beam splitter]) have limited service lives. They must be repaired or replaced if they are used for a long period of time.
- These projectors use a mercury lamp with high internal pressure. Because of its properties, this lamp may burst with a loud noise or burn out if struck or after it has been used for a period of time. The time until it bursts or burns out varies greatly according to differences between lamps and usage conditions. Turning the lamp's power on and off frequently shortens its service life.
- Optical components other than the lamp: If the projector is used for six hours or more per day, they may need to be replaced in less than a year.
- LCD panel: If the projector is used continuously for six hours or more, its replacement cycle may be shortened.
- Do not turn projector on again for ten minutes after shutdown. Neglect can shorten the lifetime of the lamp. During use and immediately after use, do not touch anywhere near the lamp and the vents as these parts are extremely hot.
- HDMI, the HDMI Logo, and High-Definition Multimedia Interface are trademarks or registered trademarks of HDMI Licensing LLC in the United States and other countries.

Remote control warning: Do not look into the laser beam. Class 2 laser product; maximum output 1mW; wavelength 650nm.

HITACHI

Hitachi America, Ltd., Digital Media Division, Business Solutions Group 900 Hitachi Way, Chula Vista, CA 91914-3556, U.S.A. and Canada
Tel: +1-800-HITACHI Fax: +1-619-591-5418 www.hitachi-america.us/digitalmedia
Hitachi Home Electronics Asia (S) Pte. Ltd. 438A Alexandra Road #01-01/02/03, Alexandra Technopark, Singapore 119967
Tel: +65-6536-2520 Fax: +65-6536-2521 www.hitachiconsumer.com.sg
Hitachi Sales (Malaysia) Sdn. Berhad (11543-V) Lot 12, Jalan Kemajuan, Bangi Industrial Estate, 43650 Bandar Baru Bangi, Selangor Darul Ehsan, Malaysia.
Tel: +60-3-8926-4168 Fax: +60-3-8926-3013 www.hitachiconsumer.com.my
Hitachi Sales (Thailand), Ltd. 994 Soi Thonglor, Sukhumvit 55 Road, Klongtonnua, Vadhana Bangkok 10110, Thailand
Tel: +66-2381-8381-98 Fax: +66-2381-0210/2381-0021 www.hitachi-th.com
Hitachi (Hong Kong), Ltd. 18th Floor, Ever Gain Centre, 28 On Muk Street, Shatin, N.T., Hong Kong Tel: +852-2113-8883 Fax: +852-2783-4178 www.hitachi-hk.com.hk
Hitachi Sales Corp. of Taiwan 2nd Floor, No.65, Nanking East Road, Section 3, Taipei 104, Taiwan Tel: +886-2-2516-0500 Fax: +886-2-2516-1501 www.hsct.com.tw
Hitachi Australia Pty Ltd. Level 3, 82 Waterloo Road, North Ryde, NSW 2113, Australia Tel: +61-2-9888-4100 Fax: +61-2-9888-4188 www.hitachi.com.au
Hitachi Europe Ltd. Whitebrook Park, Lower Cookham Road, Maidenhead, Berkshire, SL6 8YA, UK Tel: +44-1628-585000 Fax: +44-1628-643404 www.hitachidigitalmedia.com

Printed in Japan (H) NM-E359 1210

Ultimate Short Throw LCD Projectors CP-A300N/CP-A300NM/ CP-A220N/CP-A220NM

HITACHI
Inspire the Next



ULTIMATE 究極 SHORT THROW

The ideal presentation tool for
education and business

• Wall mount unit: included with CP-A300NM/CP-A220NM, optional with CP-A300N/CP-A220N.



ULTIMATE 究極 SHORT THROW

For lessons and presentations, Ultimate Short Throw projectors are an excellent choice



Ultimate Short Throw LCD Projectors
CP-A300N/CP-A300NM
XGA 3,000 Lumens
• Wall mount unit: included with CP-A300NM, optional with CP-A300N.



Ultimate Short Throw LCD Projectors
CP-A220N/CP-A220NM
XGA 2,200 Lumens
• Wall mount unit: included with CP-A220NM, optional with CP-A220N.

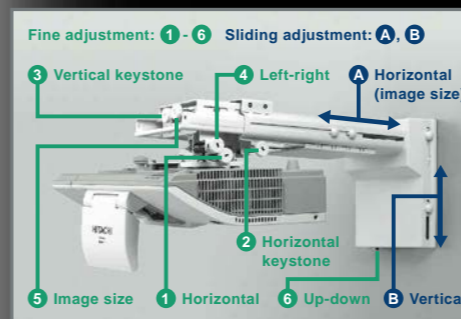

Use a large screen even in limited spaces.

These mirror projection type projectors feature Ultimate Short Throw, for projecting on a 77 type (inch), 196cm interactive whiteboard from only 51cm (20 inches). They can project on large screens even in classrooms and small meeting rooms with limited space. With a large screen, the audience will pay closer attention to the lesson or presentation.

Reduces glare and shadows.

Ultimate Short Throw greatly reduces glare from the projector's light source, making it easier for the teacher or presenter to see the audience. The audience also has a clearer view because the teacher's or presenter's hands and body shadows are minimized. The result is a better classroom or meeting room experience for both teachers or presenters and audience.

Precision control wall mount unit*.

The six-axis wall mount design ensures that the projector can be installed in exactly the right position. The entire unit slides horizontally and vertically, and fine adjustments can be made to each axis independently.

* Included with CP-A300NM/CP-A220NM, optional with CP-A300N/CP-A220N. Do not attempt to install the projector yourself. Have your dealer or service center handle all installation work.

Advanced Network Functions

Network Presentations

You can project still or moving images from one or more networked computers. The Single PC mode lets you select one computer on the network, while the Multi PC mode lets you use up to four computers. Displaying various images from computers makes lessons and presentations much more effective.

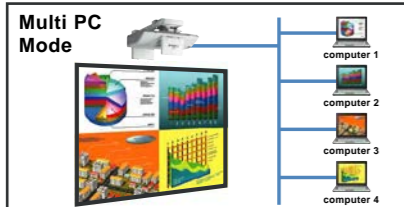
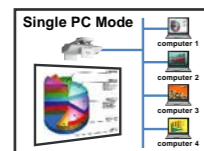

Messenger

The Messenger function transmits text data to the projector via a network, so the projector can display it. This is an easy and efficient way to send campus-wide announcements.

Messenger is ideal for:

- Campus Notifications • School Activities
- Daily Schedules • Community/Local News
- This function is not intended or guaranteed for the distribution of warning messages created by security systems.

Centralized Reporting

With just one PC in an administration room, you can collect reports from all projectors connected to the network.

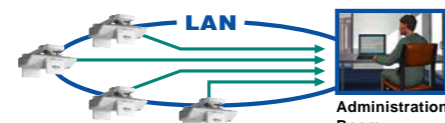

High Brightness of 3,000 Lumens

The CP-A300N and CP-A300NM feature high brightness of 3,000 lumens. (CP-A220N and CP-A220NM are 2,200 lumens)

Perfect Fit

Perfect Fit enables quick adjustment of the projected image by moving its four corners one at a time. In addition, barrel or pincushion distortion, which occur on rounded surfaces, can easily be corrected.



Superior Convenient Features

Inorganic LCD Panels

These projectors use three inorganic LCD panels, which feature higher resistance to light and offer high reliability. The use of double speed drive further improves picture quality.

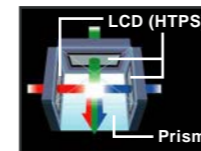

HDMI Input

With signals transferred completely in the digital domain, lessons and presentations are assured of the highest image quality.



10W Internal Speaker

These projectors have a built-in 10W high power speaker.

Easy Maintenance

The lamp door is on the top and the filter cover on the back, so maintenance and replacement of these parts can be done easily.

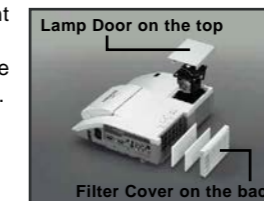

Versatile Security Functions

These projectors are equipped with a security bar, PIN Lock, MyScreen Lock and Transition Detector functions.



Hybrid Filter

The Hybrid Filter has an electrostatic design with hybrid protection filter layers, protecting the optics from dust, dirt and chalk particles. It also has a longer life than previous filters, so the projector requires less frequent maintenance.

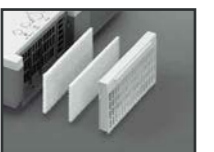

More Convenient Features

- 2,000 : 1 High Contrast Ratio (Presentation Mode)
- Low Noise of 28dB*1 (ECO Mode)
- Display via USB
- Audio Pass Through*2
- Power Saving Mode
- Template Function*3
- Daytime Mode
- My Button
- My Memory
- Input Source Naming
- 4-Second Quick Start
- Direct Power On/Off
- Closed Caption
- Compatible with AMX Device Discovery

*1 Typical. Tested in 23°C environmental conditions. *2 When in Normal mode at standby setting. It does not function in Saving mode. *3 Patent pending